



POMPA DOSATRICE TIPO LY-MX/MMX
 TESTATA A MEMBRANA IDRAULICA IN AISI-316L

INQUADRA
 4490
 SOSTITUISCE IL
 3622-R-2

REV. LINDA
 1 I/E
 DATA
 09/99



SECTIONAL DRAWING

REGOLAZIONE TIPO
 ADJUSTMENT TYPE
 STD

REGOLAZIONE TIPO
 ADJUSTMENT TYPE
 G-GS

REGOLAZIONE TIPO
 ADJUSTMENT TYPE
 Z-W

ASA Pompa Tip: LY5MX P30 DVEH 40x25 MX
Tip: LY5MX P30 DVEH 40x25 MX
 570 81 42 45 67 93 94 97 64 110 203 119 138 216 174 113 124 420

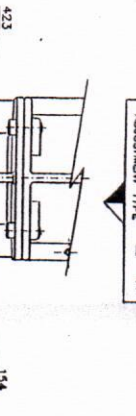
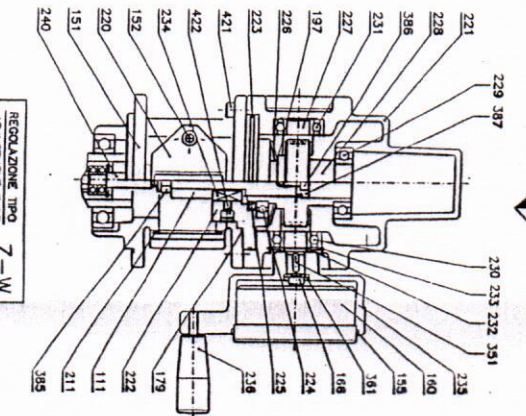
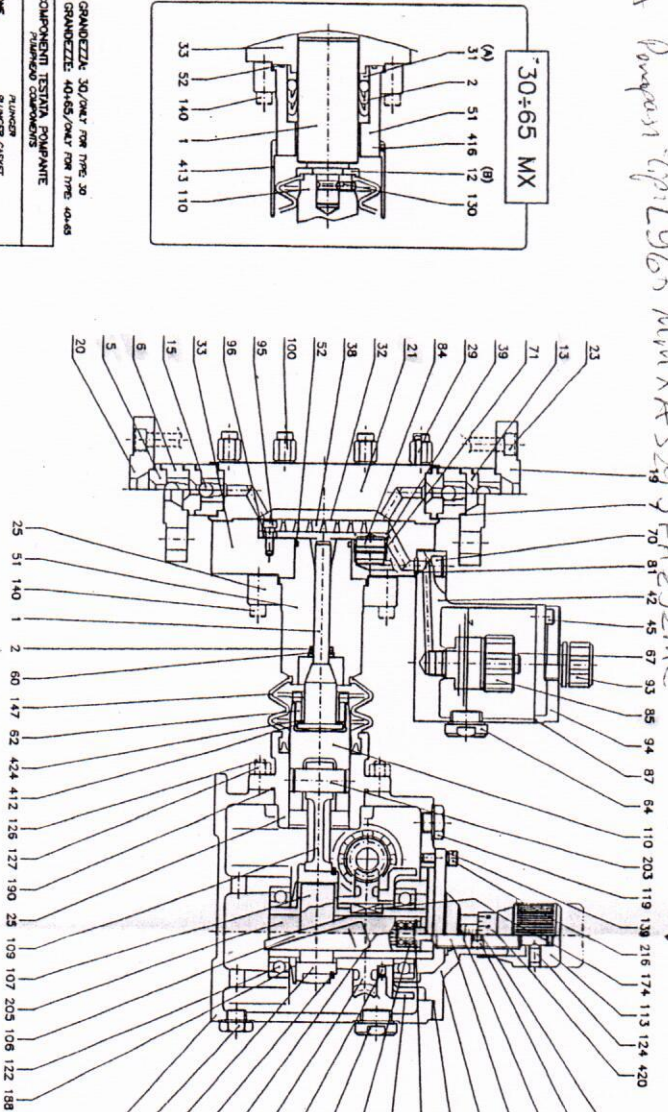
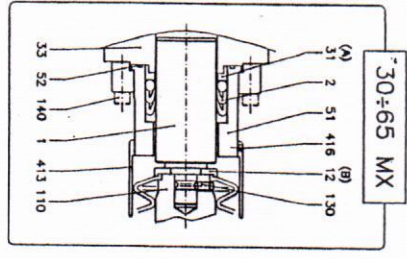

AGGI POS.197

POS./REV.	COMPONENTE TESTATA POMPANTE	NUMERO
1	PISTONE	1100
2	TESTINA PISTONE	1101
3	SECCO VALVOLA	1102
4	ORNA VALVOLA	1103
5	ORNA VALVOLA	1104
6	SECCO VALVOLA	1105
7	ORNA VALVOLA	1106
8	ORNA VALVOLA	1107
9	SECCO VALVOLA	1108
10	ORNA VALVOLA	1109
11	ORNA VALVOLA	1110
12	QUADRANTO	1111
13	SECCO VALVOLA "Y"	1112
14	ORNA VALVOLA "Y"	1113
15	VALVOLA SUBPOMPE	1114
16	FLAMBA ANTERIORE	1115
17	VALVOLA ANTERIORE	1116
18	SECCO VALVOLA	1117
19	ORNA VALVOLA	1118
20	SECCO VALVOLA	1119
21	ORNA VALVOLA	1120
22	SECCO VALVOLA	1121
23	ORNA VALVOLA	1122
24	PISTONE	1123
25	SECCO VALVOLA	1124
26	ORNA VALVOLA	1125
27	SECCO VALVOLA	1126
28	ORNA VALVOLA	1127
29	SECCO VALVOLA	1128
30	ORNA VALVOLA	1129
31	SECCO VALVOLA	1130
32	ORNA VALVOLA	1131
33	SECCO VALVOLA	1132
34	ORNA VALVOLA	1133
35	SECCO VALVOLA	1134
36	ORNA VALVOLA	1135
37	SECCO VALVOLA	1136
38	ORNA VALVOLA	1137
39	SECCO VALVOLA	1138
40	ORNA VALVOLA	1139
41	SECCO VALVOLA	1140
42	ORNA VALVOLA	1141
43	SECCO VALVOLA	1142
44	ORNA VALVOLA	1143
45	SECCO VALVOLA	1144
46	ORNA VALVOLA	1145
47	SECCO VALVOLA	1146
48	ORNA VALVOLA	1147
49	SECCO VALVOLA	1148
50	ORNA VALVOLA	1149

STANDARD	TAVAL	3978	SMA	TAVAL	3981
SSS	TAVAL	3979	SMA	TAVAL	3981
SE	TAVAL	3980	SE	TAVAL	3982

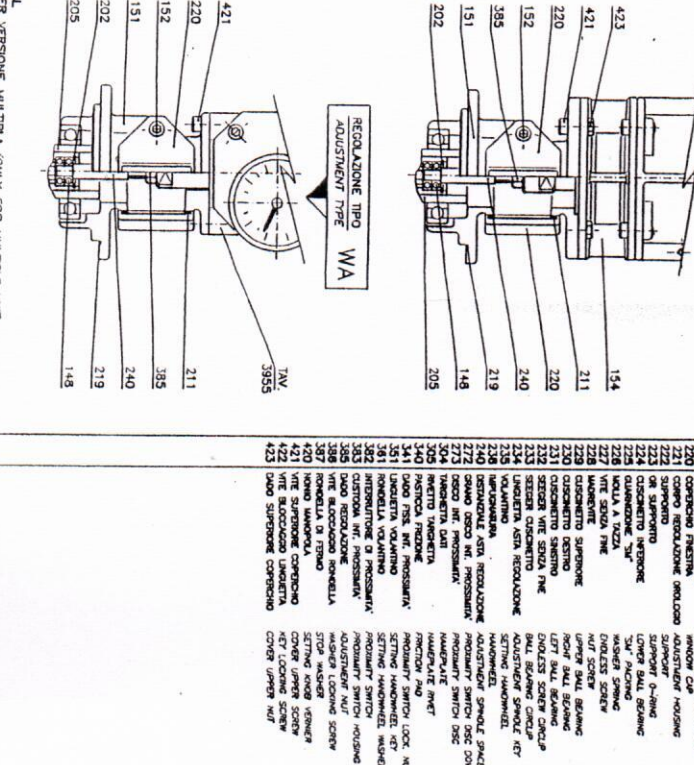
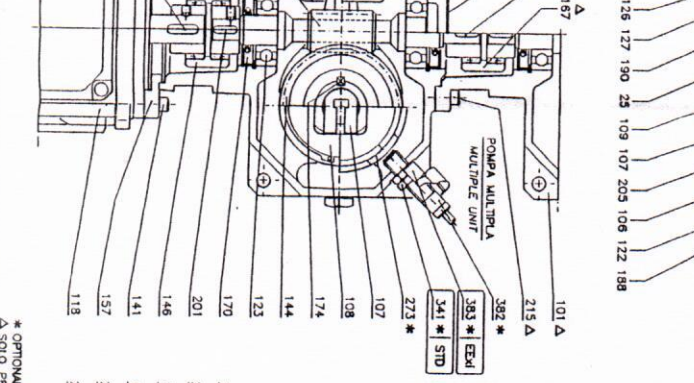
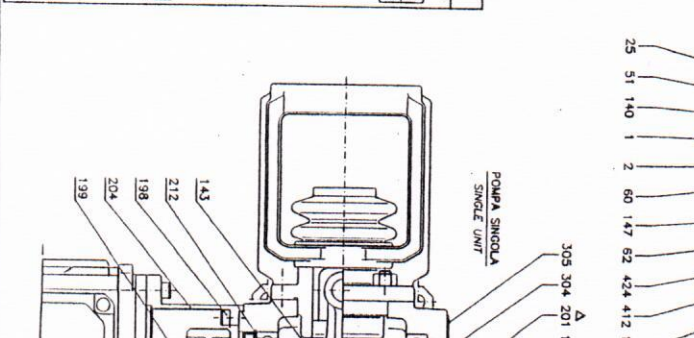

* OPZIONALE
 Δ SOLID PER VERSIONE MULTIPLEX/OONLY FOR MULTIPLE UNIT