



# JUMO dTRANS CR 02

## Transmitter/controller for conductivity, TDS, resistance, standard signals and temperature

Meets requirements of USP <645>



**JUMO dTRANS CR 02, type 202552/01... in panel case**

### Brief description

The JUMO dTRANS CR 02 is a compact, modular instrument. It is highly flexible (for example 3 slots for optional boards) and capable of performing a wide range of tasks. The main input of the JUMO dTRANS CR 02 is used for sensors for measuring electrolytic conductivity, specific resistance, or the TDS value. Both conductive two-electrode and four-electrode cells can be connected to the instrument. The second analog input (compensation input) is designed for resistance thermometers Pt100 and Pt1000, NTC/PTC or standard signals 0(4) to 20 mA or 0 to 10 V. The two binary inputs can be used either as initiators for actions (e.g. HOLD, keyboard inhibit) or when connecting pulse generators (for example impeller sensors) for flow-rate measurement. The high-contrast graphic display allows for several options including display of input signal with numbers or as bar graph. Parameters are displayed in plain text for easily comprehensible and reliable operation.

The JUMO dTRANS CR 02 can be used as a two-point or three-point controller, a three-point modulating controller, or as a continuous controller. All controller outputs can be configured to P, PI, PD or PID action. The software for the controllers includes parameter set selection, a math module and more.

A setup program is available for convenient configuration via PC. The instrument can be integrated into a data network by means of an RS422/485 or PROFIBUS-DP interface. Screw terminals on the back are used for the electrical connection.

Some applications:

- Industrial and process water.
- Drinking and well water.
- Pure, ultra-pure and pharmaceutical water (e.g. as per USP, Ph. Eur., WFI).
- Cleaning processes in pharmaceutical applications (four-electrode cells in conjunction with measuring range selection).



**JUMO dTRANS CR 02, type 202552/05... in surface-mounted case**

### Block diagram

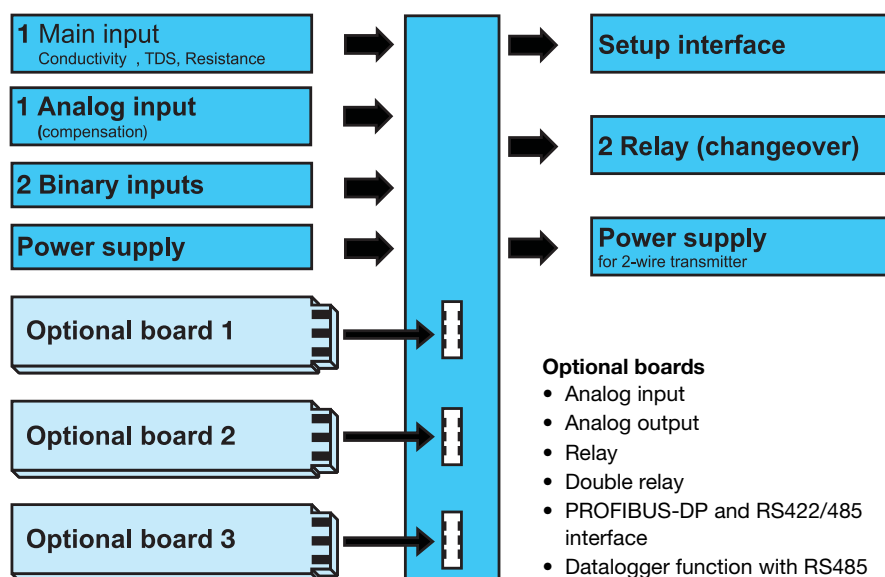

### Special features

- A choice of display visualizations: large numbers, bar graph or tendency (trend) display
- Integrated calibration routines: Cell constant, temperature coefficient
- Math and logic module
- Calibration logbook
- Integrated washing timer to control the cleaning equipment
- 13 operator languages integrated; see order details
- Setup program provides: convenient programming, system documentation
- RS422/485 interface (optional)
- PROFIBUS-DP interface (optional)
- Flush-mounted instrument - just 96 mm x 48 mm x 95 mm
- Electrode monitoring can be activated
- Flow-rate measurement

### Approvals/approval marks (see Technical data)





**Boards**

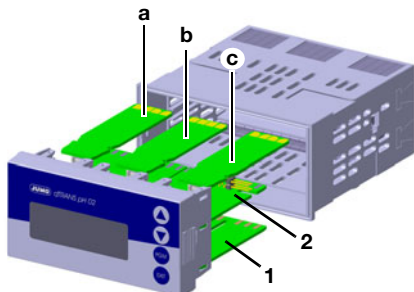

(1)	PSU board
(2)	Main board
(a)	Optional board 1
(b)	Optional board 2
(c)	Optional board 3

**PSU board (1)**

This board is always fitted in the instrument and no variations are possible.

The board includes the following items:

- The voltage supply for the JUMO dTRANS CR 02.
- The voltage supply for external 2-wire transmitters.
- 2 relays with changeover contacts.

**Main board (2)**

This board can **not** be changed subsequently! The main board (CR) has:

- The main input for connecting a two- or four-electrode conductivity cell.
- The secondary input for connecting a temperature sensor Pt100, Pt1000, a resistance transmitter or a standard signal 0(4) to 20 mA or 0 to 10 V.
- 2 binary inputs.
- The setup interface (for PC interface adapter).

**Optional board (1), (2) or (3)**

These boards are combinable and can be ordered in the following versions:

- 1 analog input
- 1 continuous output
- 1 relay (changeover)
- 2 relays (NO with common pin)
- 1 Triac (1 A)
- 1 PhotoMOS® relay (0.2 A)

The following boards can **only** be placed in slot 3, either:

- Modbus/Jbus
- PROFIBUS-DP
- Datalogger

For versions with a wall-mounted case the (re)placement of the optional boards by the customer is not possible.

**Functional description**

The instrument is a modularly designed indicator/controller for use in both simple and demanding control tasks. It can be integrated into the PLC via interfaces

To make programming and operation easy, all parameters are clearly assigned to levels and displayed in plain text. Operation is protected by a code word. Operation can be adapted on an individual basis because parameters can be generally enabled or assigned to the protected area.

A setup program for the PC is available as a more convenient configuration option, rather than using the instrument keypad.

**User data**



Up to 8 parameters that are frequently changed by the user can be combined in the user level under "User data" (via setup program only).

**Displays and controls**

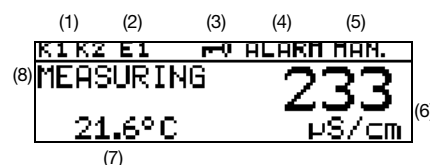

(1)	<b>Binary outputs (relays)</b> Output active if symbol is visible.
(2)	<b>Binary input</b> Input closed if symbol is visible.
(3)	<b>Keyboard inhibit</b> Keys locked if symbol is visible.
(4)	<b>Alarm message</b> ALARM (flashing): Broken sensor or overrange, etc. AL R1: Controller monitoring alarm from controller channel 1. AL R2: Controller monitoring alarm from controller channel 2. CALIB: Calibration mode active. CALIB (flashing): Calibration timer elapsed.
(5)	<b>Output mode</b> MAN.: Manual mode active. HOLD: Hold mode active.
(6)	<b>Top display</b> Measured value and unit of the variable set by parameter "Top display".

(7)	<b>Bottom display</b> Measured value and unit of the variable set by parameter "Bottom display".
(8)	<b>Operating mode</b> MEASURING: Standard measuring mode is active.

**Display modes**

The following display modes are available:

**Normal display**

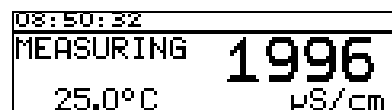

In this display method the measurements appear in numbers, as usual.

**Large display**



This method uses the complete display height.

**Tendency display**

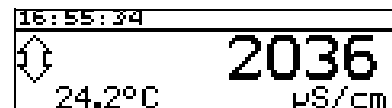

In this display a symbol is added to the numerical value to indicate the direction and speed of change for the measurement value. This can be very useful for optimizing the controller, for example.



From left to right:  
Fast, medium and slow rise, steady, slow, medium and fast fall.

**Bar graph**

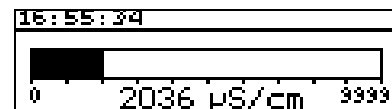

In this display mode, it only takes a glance to ascertain the range for the current measurement. Any scale can be used for the bar graph.

**Tendency curve (data monitor)**



The ring buffer contains about 100 measuring points. The sampling and storage rates can be adjusted.

**JUMO GmbH & Co. KG**

Delivery address: Mackenrodtstraße 14  
36039 Fulda, Germany  
Postal address: 36035 Fulda, Germany  
Phone: +49 661 6003-0  
Fax: +49 661 6003-607  
Email: mail@jumo.net  
Internet: www.jumo.net

**JUMO Instrument Co. Ltd.**

JUMO House  
Temple Bank, Riverway  
Harlow, Essex CM 20 2DY, UK  
Phone: +44 1279 63 55 33  
Fax: +44 1279 62 50 29  
Email: sales@jumo.co.uk  
Internet: www.jumo.co.uk

**JUMO Process Control, Inc.**

6733 Myers Road  
East Syracuse, NY 13057, USA  
Phone: +1 315 437 5866  
Fax: +1 315 437 5860  
Email: info.us@jumo.net  
Internet: www.jumousa.com

**Flow rate quantity**

K1	
FLOW RATE	0.37 l/s
VOLUME	0.61 m <sup>3</sup>
TOTAL QU.	83.61 m <sup>3</sup>

If an input has been configured for flow-rate measurement, this display can be accessed.

**Function modes of the main board****Conductivity measurement**

The measurement can be conducted either with standard two-electrode or with four-electrodes cells.

Two-electrode cells can be connected in the usual grid of cell constants (K = 0.01; 0.1; 1.0; 3.0 and 10.0). The "relative cell constant" can be adjusted over wide ranges, which makes it possible to connect sensors with different cell constants as well (for example K = 0.2).

Values K = 0.5 and 1.0 are predefined for four-electrode cells. In this case as well, the device can be adjusted to sensors with different cell constants (for example K = 0.4).

The instrument is able to perform an automatic temperature compensation.

**Resistance**

The instrument can be switched to resistance measurement for applications in which display of the resistance value is preferred over the conductivity value.

**TDS**

Display/control with the unit ppm.

The specific TDS factor can also be entered in this mode.

**Temperature compensation**

The conductivity or resistance of aqueous solutions often depends greatly on the temperature. The instrument provides the following procedures for temperature compensation, depending on the display size:

- Off (e.g. USP)
- Linear
- ASTM
- Natural waters (EN 27888/ISO 7888)

**Analog input for main board**

0(4) to 20 mA; 0 to 10 V and Pt100/Pt1000/NTC/PTC (max. 30 k $\Omega$ )/cust. specs.

Typical application: Compensation input for temperature compensation of the main measurement variable.

**Function modes of the input options, "Multi-channel mode"**

If analog inputs have been fitted (optional board), the device will have multi-channel functions. The following signal types can be processed:

- 0(4) to 20 mA
- 0 to 10 V
- Pt100/Pt1000

Sensors that return one of the output signals listed above can be connected to the instrument for the following measurement variables, for example:

- free chlorine, chlorine dioxide, ozone, hydrogen peroxide and peracetic acid as per data sheet 202630.
- pH value or redox potential as per data sheet 202705.
- Liquid level measurements.
- Flow rate measurements etc.

The instrument provides the following calibration options in this function mode:

- Zero point
- Limit value
- Zero point and limit value
- Cell constant
- Temperature coefficient

This allows optimum adaptation of the instrument to the sensor.

**Linear scaling**

Select this mode when the input signal will be displayed linearly.

One of the following units is used for display or control:

- $\mu$ S/cm
- mS/cm
- %
- mV
- pH
- ppm
- Cust. specs. (5 characters)

**Electrolytic conductivity**

$\mu$ S/cm or mS/cm are the units used for display and control.

**Specific resistance (ultra-pure water)**

Display/control with the unit k $\Omega$  × cm or M $\Omega$  × cm.

**TDS**

Display/control with the unit ppm.

The specific TDS factor can also be entered in this mode.

**Concentration**

In this mode, the concentration of a liquid can be determined from its uncompensated conductivity.

% or "Cust. specs." are the units used for display and control.

Concentration measurement:

**Caustic solution**

NaOH 0 to 15 % by wt. 0 to 90 °C  
NaOH 25 to 50 % by wt. 0 to 90 °C

**Nitric acid**

HNO<sub>3</sub> 0 to 25 % by wt. 0 to 80 °C  
HNO<sub>3</sub> 36 to 82 % by wt. -20 to 80 °C

**Sulfuric acid**

H<sub>2</sub>SO<sub>4</sub> 0 to 28 % by wt. 0 to 100 °C  
H<sub>2</sub>SO<sub>4</sub> 36 to 85 % by wt. 0 to 115 °C  
H<sub>2</sub>SO<sub>4</sub> 92 to 99 % by wt. 0 to 115 °C

**Hydrochloric acid**

HCl 0 to 18 % by wt. 0 to 65 °C  
Hal 22 to 44 % by wt. -20 to 65 °C

**Cust. specs. with table**

Non-linear correlations between the input and output variable can be processed in this mode. Typical applications include measuring the level of liquid in horizontal, cylindrical containers or simply measuring the concentration.

The input values are processed in a table (max. 20 value pairs). Values can only be entered in the table using the optional setup program.

The units used for display and control are:

- $\mu$ S/cm
- mS/cm
- Cust. specs. (5 characters)
- Use the offset parameter to adjust the display.

**Calibration****Calibration logbook**

The last five successful calibrations can be accessed from the calibration logbook. This makes it possible to evaluate the aging of the connected sensor.

The logbook can be deleted if necessary (useful when changing the sensor).

If a datalogger has been fitted (optional board), additional information such as the date and time are documented.

**Calibration timer**

The calibration timer indicates (on request) a required routine calibration. The calibration timer is activated by entering the number of days that must expire before there is a scheduled re-calibration (specified by the system or the operator).



## Additional functions of the JUMO dTRANS CR 02

### Min/max value memory

This storage records the minimum and maximum input quantities that have occurred. This information can be used, for example, to assess whether the design of the connected sensor is suitable for the values that actually occur.

### Binary input

The following functions can be accessed through the binary input:

- Key lock activation  
When this function is activated, operation is no longer possible via the keypad.
- "HOLD" mode activation  
When this function is activated, the outputs (analog and relay) adopt the states previously defined.
- Alarm suppression (controller alarm only)  
This function is used to temporarily deactivate alarm generation by means of the appropriately configured relay.
- Flow-rate measurement (counting input)  
Instantaneous value  
Partial quantity  
Total quantity

Bridging the corresponding connection terminals with a floating contact (for example a relay) activates a predefined function.

### Deposit detection

Deposit detection can be activated for four-electrode cells.

It may happen during normal operation that a coating forms on the electrodes. Because of this, the conductivity that is displayed is lower than the actual conductivity. When the "Deposit detection" function is activated, cell maintenance is required.

### Auto range

In some processes it is advantageous to have two measurement ranges available, for example in rinsing and regeneration processes.

Normally in these processes a low conductivity must be recorded exactly. In the case of rinsing/regeneration, however, the conductivity is significantly higher, which would result in measurement overrange (error). The Autorange function can be used to define two measurement ranges between which the instrument switches in a defined manner.

### Wash timer

A software function can be used to trigger cyclically recurring actions by controlling a relay.

### Control functions

Functions can be assigned to the relays. The functions can be configured in turn by parameters P, PI, PD and PID structures can be freely programmed as control functions.

### Relay outputs

Two relay changeover contacts are available for the main measurement variable and/or the temperature.

The following functions can be programmed:

- Switching direction (min/max)
- Limit controller (on-delay/delayed release, hysteresis)
- Pulse length output (see control functions)
- Pulse frequency output (see control functions)
- Modulating function (see control functions)
- Pulse functions  
With this function, the output briefly switches on when the switching point is reached and then switches off again
- Wash timer elapsed
- Alarm
- Sensor/range error
- Behavior in the event of an alarm, underrange or overrange measurement, calibration and "HOLD"

### Flow-rate measurement

Flow rate transmitters can be connected directly to the binary inputs. One input is available for "slow speed" (up to about 300 Hz) and one for "high speed" (up to about 10 kHz). The current flow rate, partial quantity and total quantity can be displayed in different units (l/s, l/min, l/h, m<sup>3</sup>/min, m<sup>3</sup>/h, GAL(US)/s, GAL(US)/min, GAL(US)/h, or l, m<sup>3</sup>, GAL(US)).

### Datalogger

Up to 43,500 data sets can be stored in the datalogger (ring buffer). Depending on the resolution, that corresponds to a storage time ranging from about 10 hours to 150 days.

Data can be read by means of the setup program and then further processed with an "Office" product.

The datalogger makes it possible to record and document processes and supports analysis of the same processes.

## Contact functions

### Max. limit function

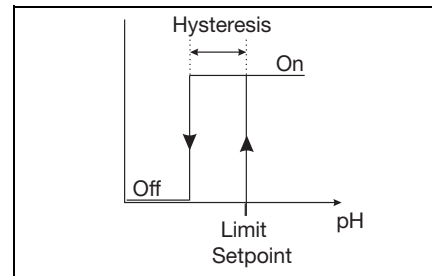

### Min. limit function

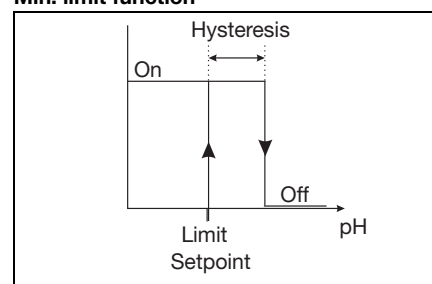

### Alarm window 1

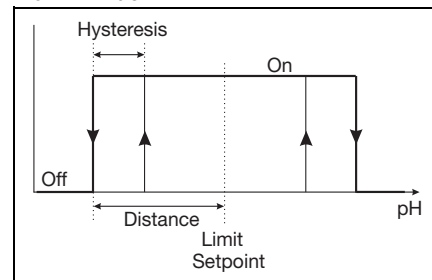

### Alarm window 2

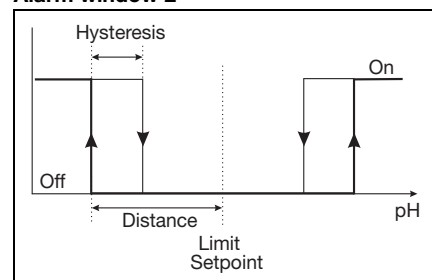

### Pulse contact

Triggering condition longer than pulse duration

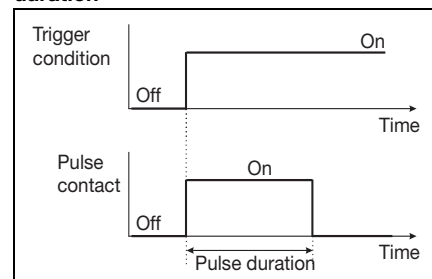



**Pulse contact**

Triggering condition shorter than pulse duration

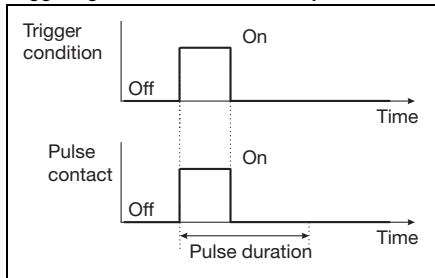

**Math and logic module**

The math module makes it possible to integrate measurement value of the analog inputs into a mathematical formula so that the calculated process variable can be displayed. The logic module can be used, for example, to link binary inputs and limit comparators with each other logically.

Up to two math or logic formulas can be entered with the optional setup program and the results of calculations can be displayed or exported via outputs (via PC setup software only).

**Setup PC program (accessory)**

The setup PC program is available in German, English and French for configuring the instrument. You can use it to create and edit sets of data and transfer them to the instrument, as well as read them out from it. The data can be stored and printed.

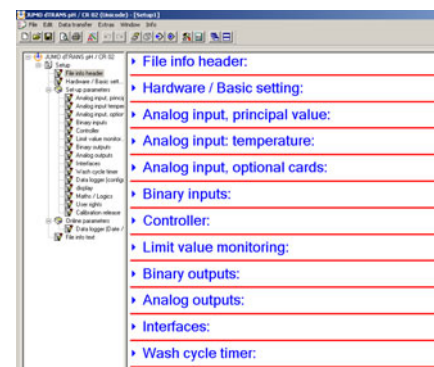

**Pulse width controller**

(output active with  $x > w$  and P control structure)

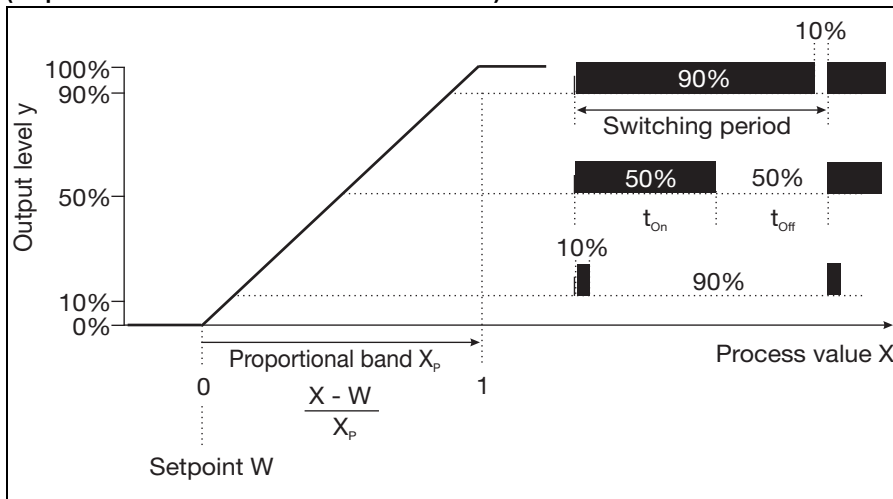

If actual value  $x$  exceeds setpoint  $w$ , the P controller will control in proportion to the control deviation. When the proportional range is exceeded, the controller operates with an output level of 100 % (100 % clock ratio).

**Pulse frequency controller**

(output active with  $x > w$  and P control structure)

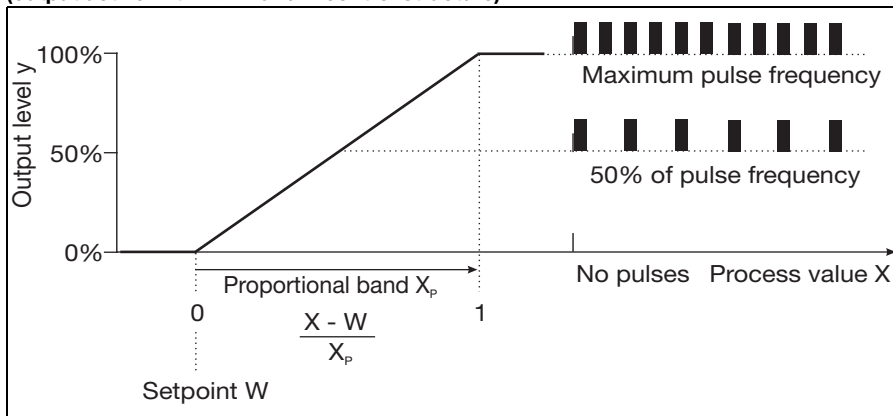

If actual value  $x$  exceeds setpoint  $w$ , the P controller will control in proportion to the control deviation. When the proportional range is exceeded, the controller operates with an output level of 100 % (maximum switching frequency).

**Setup interface**

The setup interface is integrated into the JUMO dTRANS CR 02 by default. You can use it, together with the setup program (accessory) and a setup interface (accessory), to configure the instrument.

**RS232/RS485 interface**

The serial interface is used for communication with higher-level systems when the Modbus/Jbus protocol is used.

**PROFIBUS-DP**

The JUMO dTRANS CR 02 can be integrated into a fieldbus system according to the PROFIBUS-DP standard via the PROFIBUS-DP interface. This PROFIBUS-DP version is especially designed for communication between automation systems and distributed peripheral devices at the field level and is optimized for speed.

Data is transferred serially based on the RS485 standard.

Using the project design tool that is included in the delivery (GSD generator; GSD = device master file), a standardized GSD file is created by selecting characteristic device features of the JUMO dTRANS CR 02. This file is used to integrate the controller into the fieldbus system.

**JUMO GmbH & Co. KG**  
 Delivery address: Mackenrodtstraße 14  
 36039 Fulda, Germany  
 Postal address: 36035 Fulda, Germany  
 Phone: +49 661 6003-0  
 Fax: +49 661 6003-607  
 Email: mail@jumo.net  
 Internet: www.jumo.net

**JUMO Instrument Co. Ltd.**  
 JUMO House  
 Temple Bank, Riverway  
 Harlow, Essex CM 20 2DY, UK  
 Phone: +44 1279 63 55 33  
 Fax: +44 1279 62 50 29  
 Email: sales@jumo.co.uk  
 Internet: www.jumo.co.uk

**JUMO Process Control, Inc.**  
 6733 Myers Road  
 East Syracuse, NY 13057, USA  
 Phone: +1 315 437 5866  
 Fax: +1 315 437 5860  
 Email: info.us@jumo.net  
 Internet: www.jumousa.com



## Measurement ranges/cell constants

This modern instrument features a much higher dynamic range on the input side than conductivity cells are able to control physically or chemically. The measurement range of the instrument must therefore be coordinated with the operating range of the cell.

### Sample measuring ranges for combinations with two-electrode cells

Cell constant (K)	Recommended/practical measurement scope (depending on the conductivity cell)
0.01 1/cm	0.05 µS/cm to 20 µS/cm
0.1 1/cm	1 µS/cm to 1000 µS/cm
1.0 1/cm	0.01 mS/cm to 100 ms/cm
3.0 1/cm	0.1 mS/cm to 30 ms/cm
10.0 1/cm	0.1 mS/cm to 200 ms/cm

#### Example

To conduct a measurement in the range from 10 µS/cm to 500 µS/cm, select a conductivity cell with a cell constant K = 0.1 1/cm. Configure the unit µS/cm on the instrument without places after the decimal.

### Combination with four-electrode cells and two-electrode cells with cell constant differing from the grid above

This case requires a more in-depth use of the instrument technology. Both the uncompensated and the temperature compensated measurement scope must be considered.

The uncompensated measurement scope of the instrument may be calculated according to the following formula:

$$\text{Measurement scope} = 0.1 \mu\text{S/cm} \times \text{cell constant (K)} \text{ to } 2500 \text{ mS} \times \text{cell constant (K)}$$

After consideration of the temperature compensation range, approximately the following compensated measurement scope remains:

$$\text{Measurement scope} = 0.1 \mu\text{S/cm} \times \text{cell constant (K)} \text{ to } 1250 \text{ mS} \times \text{cell constant (K)}$$

Cell constant (K)	Measurement scope based on instrument (temperature-compensated)
0.01	0.001 µS/cm to 1.25 ms/cm
0.1	0.01 µS/cm to 12.5 ms/cm
1.0	0.1 µS/cm to 125 ms/cm
3.0	0.3 µS/cm to 375 ms/cm
10.0	0.1 mS/cm to 1250 ms/cm

It may be assumed that the measurement scope of the instrument is always greater than the recommended or practically usable range of the conductivity cell that is used.

The smaller range (instrument or conductivity cell) determines the maximum usable range.

#### Example

What measurement scope can the instrument cover with a specified cell constant?

The specified cell constant is K = 0.4

$$\text{The measurement scope of the instrument} = 0.1 \mu\text{S/cm} \times 0.4 \text{ 1/cm} \text{ to } 1250 \text{ mS/cm} \times 0.4 \text{ 1/cm} \\ \rightarrow 0.04 \mu\text{S/cm} \text{ to } 500 \text{ mS/cm}$$

**JUMO GmbH & Co. KG**  
 Delivery address: Mackenrodtstraße 14  
 36039 Fulda, Germany  
 Postal address: 36035 Fulda, Germany  
 Phone: +49 661 6003-0  
 Fax: +49 661 6003-607  
 Email: mail@jumo.net  
 Internet: www.jumo.net

**JUMO Instrument Co. Ltd.**  
 JUMO House  
 Temple Bank, Riverway  
 Harlow, Essex CM 20 2DY, UK  
 Phone: +44 1279 63 55 33  
 Fax: +44 1279 62 50 29  
 Email: sales@jumo.co.uk  
 Internet: www.jumo.co.uk

**JUMO Process Control, Inc.**  
 6733 Myers Road  
 East Syracuse, NY 13057, USA  
 Phone: +1 315 437 5866  
 Fax: +1 315 437 5860  
 Email: info.us@jumo.net  
 Internet: www.jumousa.com



## Technical data

### Inputs (main board)

Main input	Measuring range/control range	Accuracy	Effect of temperature
$\mu\text{S/cm}$	0.000 to 9.999 00.00 to 99.99 000.0 to 999.9 0000 to 9999	$\leq 0.6\%$ of range + $0.3\ \mu\text{S} \times \text{cell constant (K)}$	0.2 %/10 K
$\text{mS/cm}$	0.000 to 9.999 00.00 to 99.99 000.0 to 999.9 0000 to 9999 <sup>a</sup>	$\leq 0.6\%$ of range + $0.3\ \mu\text{S} \times \text{cell constant (K)}$	0.2 %/10 K
$\text{k}\Omega \times \text{cm}$	0.000 to 9.999 00.00 to 99.99 000.0 to 999.9 0000 to 9999	$\leq 0.6\%$ of range + $0.3\ \mu\text{S} \times \text{cell constant (K)}$	0.2 %/10 K
$\text{M}\Omega \times \text{cm}$	0.000 to 9.999 00.00 to 99.99 000.0 to 999.9 0000 to 9999	$\leq 0.6\%$ of range + $0.3\ \mu\text{S} \times \text{cell constant (K)}$	0.2 %/10 K
<b>Secondary input</b>			
Temperature Pt100/1000	-50 to +250 °C <sup>b</sup>	$\leq 0.25\%$ of range	0.2 %/10 K
Temperature NTC/PTC	0.1 to 30 k $\Omega$ Entry via table with 20 value pairs	$\leq 1.5\%$ of range	0.2 %/10 K
Standard signal	0(4) to 20 mA or 0 to 10 V	0.25% of range	0.2 %/10 K
Resistance transmitter	Minimum: 100 $\Omega$ Maximum: 3 k $\Omega$	$\pm 5\ \Omega$	0.1 %/10 K

<sup>a</sup> In the range between 1 to 10 S the accuracy is 1 % of the measuring range.

<sup>b</sup> Selectable in °F

### Resistance thermometer inputs (optional board)

Designation	Connection type	Measuring range	Measuring accuracy		Effect of ambient temperature
			3-wire/4-wire	2-wire	
Pt100 DIN EN 60751 (factory-set)	2-wire/3-wire/ 4-wire	-200 to +850 °C	$\leq 0.05\%$	$\leq 0.4\%$	50 ppm/K
Pt1000 DIN EN 60751 (factory-set)	2-wire/3-wire/ 4-wire	-200 to +850 °C	$\leq 0.1\%$	$\leq 0.2\%$	50 ppm/K
Sensor lead resistance	Maximum 30 $\Omega$ per line with 3- and 4-wire circuit				
Measurement current	Approx. 250 $\mu\text{A}$				
Lead compensation	Not required for 3- and 4-wire circuit. With a 2-wire circuit, lead resistance can be compensated in the software by correcting the process value.				

### Standard signals inputs (optional board)

Designation	Measuring range	Measuring accuracy	Effect of ambient temperature
Voltage	0(2) to 10 V 0 to 1 V Input resistance <sub>E</sub> > 100 k $\Omega$	$\leq 0.05\%$	100 ppm/K
Electrical current	0(4) to 20 mA, voltage drop $\leq 1.5\ \text{V}$	$\leq 0.05\%$	100 ppm/K
Resistance transmitter	Minimum: 100 $\Omega$ Maximum: 4 k $\Omega$	$\pm 4\ \Omega$	100 ppm/K

**JUMO GmbH & Co. KG**  
 Delivery address: Mackenrodtstraße 14  
 36039 Fulda, Germany  
 Postal address: 36035 Fulda, Germany  
 Phone: +49 661 6003-0  
 Fax: +49 661 6003-607  
 Email: mail@jumo.net  
 Internet: www.jumo.net

**JUMO Instrument Co. Ltd.**  
 JUMO House  
 Temple Bank, Riverway  
 Harlow, Essex CM 20 2DY, UK  
 Phone: +44 1279 63 55 33  
 Fax: +44 1279 62 50 29  
 Email: sales@jumo.co.uk  
 Internet: www.jumo.co.uk

**JUMO Process Control, Inc.**  
 6733 Myers Road  
 East Syracuse, NY 13057, USA  
 Phone: +1 315 437 5866  
 Fax: +1 315 437 5860  
 Email: info.us@jumo.net  
 Internet: www.jumousa.com



**Temperature compensation**

Type of compensation	Range <sup>a</sup>
Linear 0 to 8 %/K	-10 to +160 °C
ASTM D1125 - 95 (ultra-pure water)	0 to 100 °C
Natural waters (ISO 7888)	0 to 36 °C
<b>Reference temperature</b>	
Adjustable from 15 to 30 °C; preset to 25 °C (default)	

<sup>a</sup> Note the sensor operating temperature range!

**Measuring circuit monitoring**

Inputs	Underrange/overrange	Short circuit	Broken lead
Conductivity	Yes	Depends on measuring range	Depends on measuring range
Temperature	Yes	Yes	Yes
Voltage 2 to 10 V 0 to 10 V	Yes	Yes	Yes
	Yes	No	No
Current 4 to 20 mA 0 to 20 mA	Yes	Yes	Yes
	Yes	No	No
Resistance transmitter	No	No	Yes

**Two-electrode systems**

Cell constant [1/cm]	Setting range of the relative cell constant	Resulting usable range [1/cm]
0.01	20 to 500 %	0.002 to 0.05
0.1		0.02 to 0.5
1.0		0.2 to 5
3.0		0.6 to 15
10.0		2.0 to 50

**Four-electrode systems**

Cell constant [1/cm]	Setting range of the relative cell constant	Resulting usable range [1/cm]
0.5	20 to 150 %	0.1 to 0.75
1.0		0.2 to 1.5

**Binary input**

Activation	Floating contact is open: function is not active Floating contact is closed: function is active
Function	Key lock, manual mode, HOLD, HOLD inverse, alarm suppression, freeze measured value, level lock, reset day counter, reset total counter, parameter set changeover, flow-rate measurement
Pulse input for flow measurement	Binary input 1: approx. 3 to 2000 Hz, resolution 2 Hz Binary input 2: approx. 4 to 300 Hz, resolution 0,5 Hz At the device only one binary input for flow measurement can be used.

**Controller**

Controller type	Limit comparators, limit controllers, pulse length controllers, pulse frequency controllers, modulating controllers, continuous controllers
Controller structure	P/PI/PD/PID



**JUMO GmbH & Co. KG**  
 Delivery address: Mackenrodtstraße 14  
 36039 Fulda, Germany  
 Postal address: 36035 Fulda, Germany  
 Phone: +49 661 6003-0  
 Fax: +49 661 6003-607  
 Email: mail@jumo.net  
 Internet: www.jumo.net

**JUMO Instrument Co. Ltd.**  
 JUMO House  
 Temple Bank, Riverway  
 Harlow, Essex CM 20 2DY, UK  
 Phone: +44 1279 63 55 33  
 Fax: +44 1279 62 50 29  
 Email: sales@jumo.co.uk  
 Internet: www.jumo.co.uk

**JUMO Process Control, Inc.**  
 6733 Myers Road  
 East Syracuse, NY 13057, USA  
 Phone: +1 315 437 5866  
 Fax: +1 315 437 5860  
 Email: info.us@jumo.net  
 Internet: www.jumousa.com



**Outputs**

Relay (changeover) Contact rating Contact service life	PSU board	5 A at AC 240 V resistive load 350,000 operations at nominal load/750,000 operations at 1 A
Voltage supply for 2-wire transmitter	PSU board	Electrically isolated, non-controlled DC 17 V at 20 mA, open-circuit voltage approx. DC 25 V
Voltage supply for inductive proximity switch	Optional board	DC 12 V; 10 mA
Relay (changeover) Contact rating Contact service life	Optional board	8 A at AC 240 V resistive load 100,000 operations at nominal load/350,000 operations at 3 A
Relay SPST (normally open) Contact rating Contact service life	Optional board	3 A at AC 240 V resistive load 350,000 operations at nominal load/900,000 operations at 1 A
Semiconductor relay Contact rating Protective circuit	Optional board	1 A at 240 V Varistor
PhotoMOS <sup>®</sup> relay	Optional board	U ≤ DC 45 V U ≤ AC 30 V I ≤ 200 mA
Voltage Output signals Load resistance Accuracy	Optional board	0 to 10 V or 2 to 10 V R <sub>load</sub> ≥ 500 Ω ≤ 0.5 %
Electrical current Output signals Load resistance Accuracy	Optional board	0 to 20 mA or 4 to 20 mA R <sub>load</sub> ≤ 500 Ω ≤ 0.5 %

**Display**

Type	LC graphic display, blue with background lighting, 122 × 32 pixels
------	--

**Electrical data**

Voltage supply (switch-mode PSU)	AC 110 to 240 V +10/-15 %; 48 to 63 Hz or AC/DC 20to30 V; 48 to 63 Hz
Electrical safety	To DIN EN 61010, Part 1 overvoltage category II, pollution degree 2
Power consumption	Max. 14 VA (20 A fuse max.)
Data backup	EEPROM
Electrical connection	On the back via screw terminals, conductor cross-section up to max. 2.5 mm <sup>2</sup>
Electromagnetic Compatibility (EMC) Interference emission Interference immunity	DIN EN 61326-1 Class A To industrial requirements

**JUMO GmbH & Co. KG**

Delivery address: Mackenrodtstraße 14  
36039 Fulda, Germany  
Postal address: 36035 Fulda, Germany  
Phone: +49 661 6003-0  
Fax: +49 661 6003-607  
Email: mail@jumo.net  
Internet: www.jumo.net

**JUMO Instrument Co. Ltd.**

JUMO House  
Temple Bank, Riverway  
Harlow, Essex CM 20 2DY, UK  
Phone: +44 1279 63 55 33  
Fax: +44 1279 62 50 29  
Email: sales@jumo.co.uk  
Internet: www.jumo.co.uk

**JUMO Process Control, Inc.**

6733 Myers Road  
East Syracuse, NY 13057, USA  
Phone: +1 315 437 5866  
Fax: +1 315 437 5860  
Email: info.us@jumo.net  
Internet: www.jumousa.com

**Case**

Enclosure type	Plastic case for panel mounting to DIN IEC 61554 (indoor use)
Depth behind panel	90 mm
Ambient temperature	-5 to +55 °C
Storage temperature	-30 to +70 °C
Climatic rating	Rel. humidity ≤ 90 % annual mean, no condensation
Site altitude	Up to 2000 m above sea level
Operating position	Horizontal
Enclosure protection	To DIN EN 60529
In panel case	Front IP65, rear IP20
In surface-mounted case	IP65
Weight (fully fitted)	Approx. 380 g

**Interface**

<b>Modbus</b>	
Interface type	RS422/RS485
Protocol	Modbus, Modbus Integer
Baud rate	9600, 19200, 38400
Device address	0 to 255
Max. number of nodes	32
<b>PROFIBUS-DP</b>	
Device address	0 to 255

**Approvals/approval marks**

Mark of conformity	Testing laboratory	Certificates/certification numbers	Test basis	valid for
c UL us	Underwriters Laboratories	E 201387	UL 61010-1 CAN/CSA-C22.2 No. 61010-1	Type 202552/01...

**JUMO GmbH & Co. KG**  
 Delivery address: Mackenrodtstraße 14  
 36039 Fulda, Germany  
 Postal address: 36035 Fulda, Germany  
 Phone: +49 661 6003-0  
 Fax: +49 661 6003-607  
 Email: mail@jumo.net  
 Internet: www.jumo.net

**JUMO Instrument Co. Ltd.**  
 JUMO House  
 Temple Bank, Riverway  
 Harlow, Essex CM 20 2DY, UK  
 Phone: +44 1279 63 55 33  
 Fax: +44 1279 62 50 29  
 Email: sales@jumo.co.uk  
 Internet: www.jumo.co.uk

**JUMO Process Control, Inc.**  
 6733 Myers Road  
 East Syracuse, NY 13057, USA  
 Phone: +1 315 437 5866  
 Fax: +1 315 437 5860  
 Email: info.us@jumo.net  
 Internet: www.jumousa.com



## Electrical connection

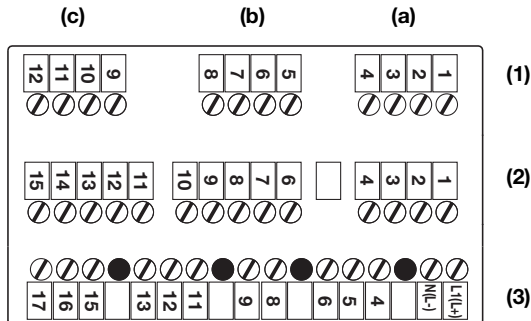

### Mounting information for conductor cross-sections and ferrules

Ferrule	Conductor cross-section		Minimum ferrule length or stripping
	Minimum	Maximum	
Without ferrule	0.34 mm <sup>2</sup>	2.5 mm <sup>2</sup>	10 mm (stripping)
Without collar	0.25 mm <sup>2</sup>	2.5 mm <sup>2</sup>	10 mm
With collar up to 1.5 mm <sup>2</sup>	0.25 mm <sup>2</sup>	1.5 mm <sup>2</sup>	10 mm
Twin, with collar	0.25 mm <sup>2</sup>	1.5 mm <sup>2</sup>	12 mm

(1)	Row 1	(a)	Option 1	(b)	Option 2	(c)	Option 3
(2)	Row 2	Main board (conductivity/resistance/temperature/standard signal)					
(3)	Row 3	PSU board (voltage supply/2x relays)					

### Optional board (row 1, slot a, b or c)

Function	Symbol	Terminal for slot (a)	Terminal for slot (b)	Terminal for slot (c)
<b>Analog input</b>				
<b>Temperature sensor in a 2-wire circuit</b> Pt100 or Pt1000		2 4	6 8	10 12
<b>Temperature sensor in a 3-wire circuit</b> Pt100 or Pt1000		2 3 4	6 7 8	10 11 12
<b>Resistance transmitter</b>		2 3 4	6 7 8	10 11 12
<b>Electrical current</b>		3 4	7 8	11 12
<b>Voltage</b> 0(2) to 10 V		1 2	5 6	9 10
<b>Voltage</b> 0 to 1 V		2 3	6 7	10 11
<b>Continuous output</b>				
<b>Current or voltage</b>		2 3	6 7	10 11
<b>Modbus interface</b>				
RS422		-	-	9 10 11 12
RS485		-	-	11 12

**JUMO GmbH & Co. KG**  
 Delivery address: Mackenrodtstraße 14  
 36039 Fulda, Germany  
 Postal address: 36035 Fulda, Germany  
 Phone: +49 661 6003-0  
 Fax: +49 661 6003-607  
 Email: mail@jumo.net  
 Internet: www.jumo.net

**JUMO Instrument Co. Ltd.**  
 JUMO House  
 Temple Bank, Riverway  
 Harlow, Essex CM 20 2DY, UK  
 Phone: +44 1279 63 55 33  
 Fax: +44 1279 62 50 29  
 Email: sales@jumo.co.uk  
 Internet: www.jumo.co.uk

**JUMO Process Control, Inc.**  
 6733 Myers Road  
 East Syracuse, NY 13057, USA  
 Phone: +1 315 437 5866  
 Fax: +1 315 437 5860  
 Email: info.us@jumo.net  
 Internet: www.jumousa.com



Function	Symbol	Terminal for slot (a)	Terminal for slot (b)	Terminal for slot (c)
<b>PROFIBUS-DP interface</b>				
	VP(+5V) RxD/TxD-P(B) RxD/TxD-N(A) DGND	-	-	9 10 11 12
<b>Datalogger interface</b>				
RS485	RxD/TxD+ RxD/TxD-	-	-	10 11
<b>Relay (1x changeover)</b>				
		K3 1 2 3	K4 5 6 7	K5 9 10 11
<b>Relay (2x NO, common pin)</b>				
		K3 1 2 K6 3	-	K5 9 10 K8 11
<b>Triac (1 A)</b>				
		K3 2 3	K4 6 7	K5 10 11
<b>PhotoMOS<sup>®</sup> relay (0.2 A)</b>				
		K3 1 2	K4 5 6	K5 9 10
		K6 3 4	K7 7 8	K8 11 12

**Main board (row 2)**

Function	Symbol	Terminal
<b>Standard signal input for electrical current</b> 0(4) to 20 mA		3 4
<b>Standard signal input for voltage</b> 0(2) to 10 V or 10 to 0(2) V		1 4
<b>Temperature sensor in a 2-wire circuit</b> Pt100 or Pt1000		2 3 4
<b>Temperature sensor in a 3-wire circuit</b> Pt100 or Pt1000		2 3 4
<b>Resistance transmitter</b>		4 3 2

**JUMO GmbH & Co. KG**  
 Delivery address: Mackenrodtstraße 14  
 36039 Fulda, Germany  
 Postal address: 36035 Fulda, Germany  
 Phone: +49 661 6003-0  
 Fax: +49 661 6003-607  
 Email: mail@jumo.net  
 Internet: www.jumo.net

**JUMO Instrument Co. Ltd.**  
 JUMO House  
 Temple Bank, Riverway  
 Harlow, Essex CM 20 2DY, UK  
 Phone: +44 1279 63 55 33  
 Fax: +44 1279 62 50 29  
 Email: sales@jumo.co.uk  
 Internet: www.jumo.co.uk

**JUMO Process Control, Inc.**  
 6733 Myers Road  
 East Syracuse, NY 13057, USA  
 Phone: +1 315 437 5866  
 Fax: +1 315 437 5860  
 Email: info.us@jumo.net  
 Internet: www.jumousa.com



Function	Symbol	Terminal
<b>Conductivity cell</b>		
Conductivity cell (2-electrode system) Terminals 6+7 and 8+9 can be bridged on the instrument; 2-wire cable routing up to the head of the conductivity cell. For concentric cells, terminal 6 must be connected with the outer electrode.		6 7 8 9
Conductivity cell (2-electrode system) Wiring for highest accuracy; 4-wire cable routing to the head of the conductivity cell. For concentric cells, terminal 6 must be connected with the outer electrode.		6 7 8 9
Conductivity cell (4-electrode system) 6 - Outer electrode 1 7 - Inner electrode 1 8 - Inner electrode 2 9 - Outer electrode 2		6 7 8 9
<b>Shield connection</b>		
Conductivity cell		10 GND
<b>Binary inputs<sup>a</sup></b>		
Binary input 1 3 to 2000 Hz, resolution 2 Hz		12+ 14
Binary input 2 4 to 300 Hz, resolution 0,5 Hz		13+ 14

<sup>a</sup> The binary inputs can be used as counter inputs for flow measurement with flow sensors (see application example on Seite 16).

**PSU board (row 3)**

Function	Symbol	Terminal
<b>Voltage supply for JUMO dTRANS 02</b>		
Voltage supply: AC 110 to 240 V Voltage supply: AC/DC 20 to 30 V		1 L1 (L+) 2 N (L-)
n.c.		4 5 6
<b>Voltage supply for external 2-wire transmitter</b>		
DC 24 V (+20/-15 %)		8 L + 9 L -
<b>Relay 1</b>		
Switching output K1 (floating)		11 12 13
<b>Relay 2</b>		
Switching output K2 (floating)		15 16 17

**JUMO GmbH & Co. KG**  
 Delivery address: Mackenrodtstraße 14  
 36039 Fulda, Germany  
 Postal address: 36035 Fulda, Germany  
 Phone: +49 661 6003-0  
 Fax: +49 661 6003-607  
 Email: mail@jumo.net  
 Internet: www.jumo.net

**JUMO Instrument Co. Ltd.**  
 JUMO House  
 Temple Bank, Riverway  
 Harlow, Essex CM 20 2DY, UK  
 Phone: +44 1279 63 55 33  
 Fax: +44 1279 62 50 29  
 Email: sales@jumo.co.uk  
 Internet: www.jumo.co.uk

**JUMO Process Control, Inc.**  
 6733 Myers Road  
 East Syracuse, NY 13057, USA  
 Phone: +1 315 437 5866  
 Fax: +1 315 437 5860  
 Email: info.us@jumo.net  
 Internet: www.jumousa.com



## Dimensions

### Panel case

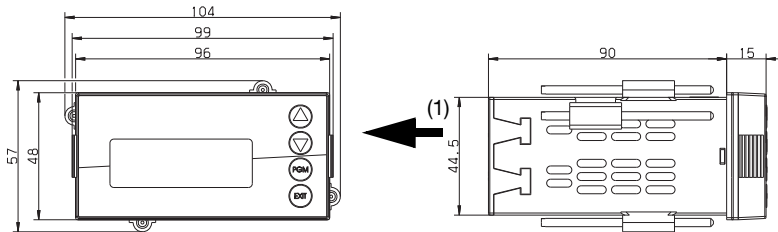

### Close mounting

Minimum spacing of panel cutouts	Horizontal	Vertical
Without setup connector	30 mm	11 mm
With setup connector (see arrow)	65 mm	11 mm

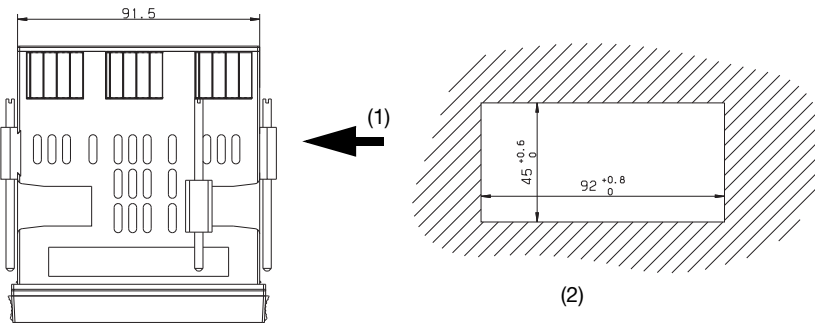

- (1) PC interface socket
- (2) Panel cutout to DIN IEC 61554: 2002-08

### Surface-mounted case

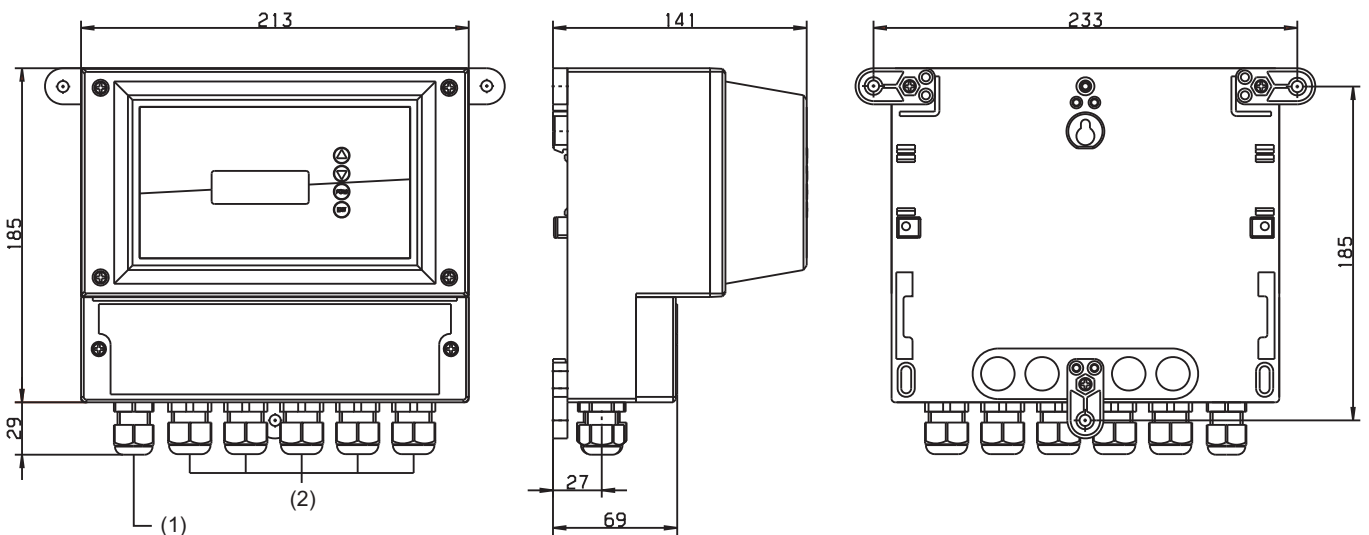

- (1) Cable gland M16
- (2) Cable gland M20

**JUMO GmbH & Co. KG**  
 Delivery address: Mackenrodtstraße 14  
 36039 Fulda, Germany  
 Postal address: 36035 Fulda, Germany  
 Phone: +49 661 6003-0  
 Fax: +49 661 6003-607  
 Email: mail@jumo.net  
 Internet: www.jumo.net

**JUMO Instrument Co. Ltd.**  
 JUMO House  
 Temple Bank, Riverway  
 Harlow, Essex CM 20 2DY, UK  
 Phone: +44 1279 63 55 33  
 Fax: +44 1279 62 50 29  
 Email: sales@jumo.co.uk  
 Internet: www.jumo.co.uk

**JUMO Process Control, Inc.**  
 6733 Myers Road  
 East Syracuse, NY 13057, USA  
 Phone: +1 315 437 5866  
 Fax: +1 315 437 5860  
 Email: info.us@jumo.net  
 Internet: www.jumousa.com



## Application examples

### Conductivity measurement (temperature compensated)

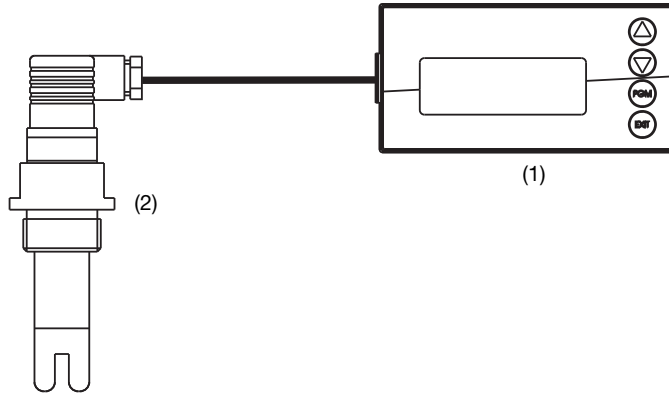

- (1) JUMO dTRANS CR 02
- (2) Conductivity sensor

### Redox measurement and conductivity measurement (temperature compensated)

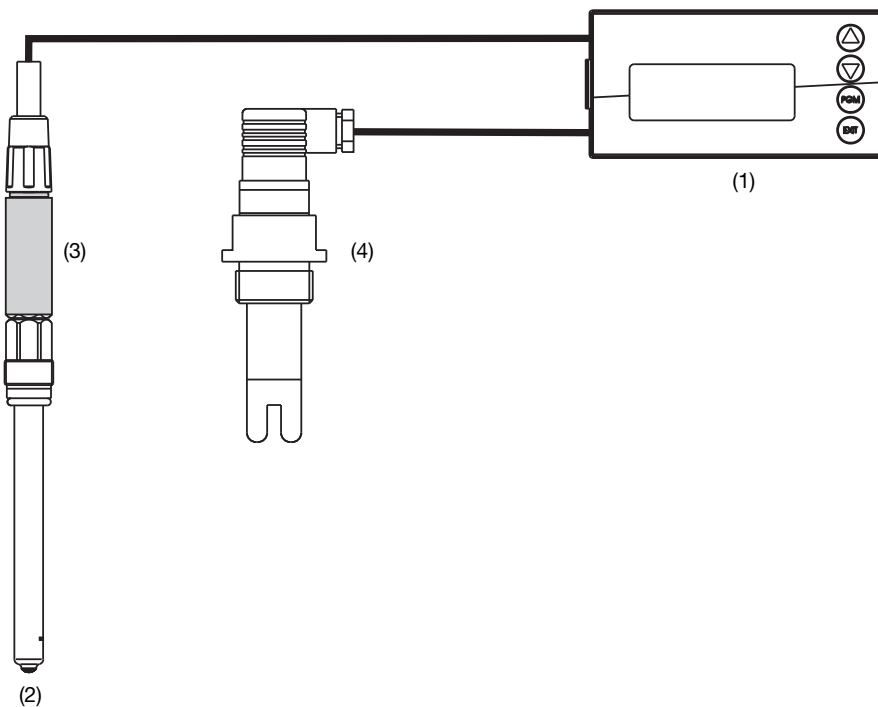

- (1) JUMO dTRANS CR 02
- (2) Redox combination electrode
- (3) JUMO digiLine pH/ORP/T with analog output, type 202705
- (4) Conductivity sensor

**JUMO GmbH & Co. KG**  
 Delivery address: Mackenrodtstraße 14  
 36039 Fulda, Germany  
 Postal address: 36035 Fulda, Germany  
 Phone: +49 661 6003-0  
 Fax: +49 661 6003-607  
 Email: mail@jumo.net  
 Internet: www.jumo.net

**JUMO Instrument Co. Ltd.**  
 JUMO House  
 Temple Bank, Riverway  
 Harlow, Essex CM 20 2DY, UK  
 Phone: +44 1279 63 55 33  
 Fax: +44 1279 62 50 29  
 Email: sales@jumo.co.uk  
 Internet: www.jumo.co.uk

**JUMO Process Control, Inc.**  
 6733 Myers Road  
 East Syracuse, NY 13057, USA  
 Phone: +1 315 437 5866  
 Fax: +1 315 437 5860  
 Email: info.us@jumo.net  
 Internet: www.jumousa.com



**Conductivity measurement and level or liquid level measurement<sup>1</sup>**

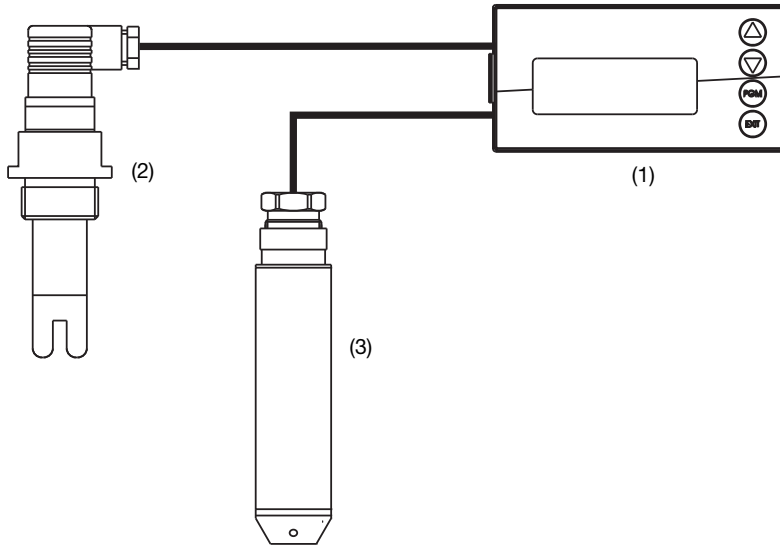

- (1) JUMO dTRANS CR 02
- (2) Conductivity sensor
- (3) Level measurement probe, type JUMO dTRANS p90 or type 402090 or type 404391

<sup>1</sup> The setup program, which is available as an option, can be used to linearly assign a display in liters or other unit to a non-linear input variable such as the volume of a horizontal, cylindrical tank (20 value pairs).

**Conductivity measurement and flow-rate measurement**

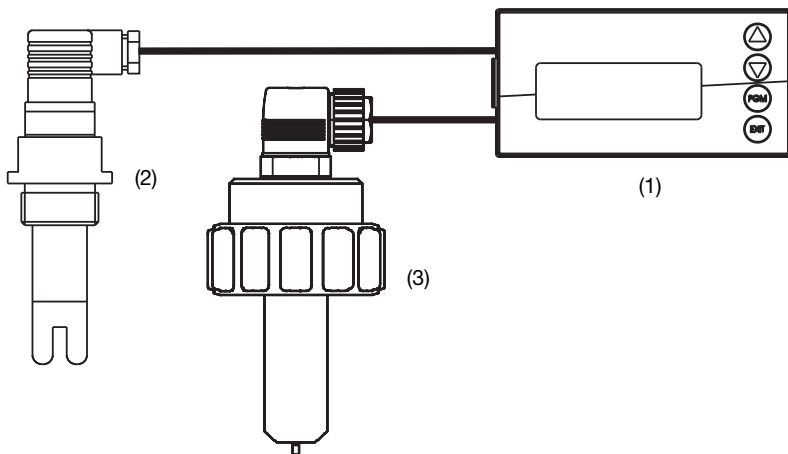

- (1) JUMO dTRANS CR 02
- (2) Conductivity sensor
- (3) Flow sensor, type 406010 (magnetic-inductive) or type 406020 (padle wheel)



**JUMO GmbH & Co. KG**

Delivery address: Mackenrodtstraße 14  
36039 Fulda, Germany  
Postal address: 36035 Fulda, Germany  
Phone: +49 661 6003-0  
Fax: +49 661 6003-607  
Email: mail@jumo.net  
Internet: www.jumo.net

**JUMO Instrument Co. Ltd.**

JUMO House  
Temple Bank, Riverway  
Harlow, Essex CM 20 2DY, UK  
Phone: +44 1279 63 55 33  
Fax: +44 1279 62 50 29  
Email: sales@jumo.co.uk  
Internet: www.jumo.co.uk

**JUMO Process Control, Inc.**

6733 Myers Road  
East Syracuse, NY 13057, USA  
Phone: +1 315 437 5866  
Fax: +1 315 437 5860  
Email: info.us@jumo.net  
Internet: www.jumousa.com

**Order details**

<b>(1) Basic type</b>	
202552/01	JUMO dTRANS CR 02 - Transmitter/controller for conductivity, TDS, resistance, standard signals and temperature in panel case, 96 mm x 48 mm (front IP65)
202552/05	JUMO dTRANS CR 02 - Transmitter/controller for conductivity, TDS, resistance, standard signals and temperature in surface-mounted case, 96 mm x 48 mm (IP67)
<b>(2) Version</b>	
8	Standard with factory setting
9	Programming to customer specification
<b>(3) Operating language<sup>a</sup></b>	
01	German
02	English
03	French
04	Dutch
05	Russian
06	Italian
07	Hungarian
08	Czech
09	Swedish
10	Polish
13	Portuguese
14	Spanish
16	Rumanian
<b>(4) Optional slot 1</b>	
0	Not used
1	Analog input 2 (universal)
2	Relay (1x changeover)
3	Relay (2x normally open)
4	Analog output
5	2 PhotoMOS <sup>®</sup> relay
6	Solid state relay 1 A
8	Voltage supply output DC 12 V (e.g. for inductive proximity switch)
<b>(5) Optional slot 2</b>	
0	Not used
1	Analog input 2 (universal)
2	Relay (1x changeover)
4	Analog output
5	2 PhotoMOS <sup>®</sup> relay
6	Solid state relay 1 A
8	Voltage supply output DC 12 V (e.g. for inductive proximity switch)
<b>(6) Optional slot 3</b>	
0	Not used
1	Analog input 2 (universal)
2	Relay (1x changeover)
3	Relay (2x normally open)
4	Analog output
5	2 PhotoMOS <sup>®</sup> relay
6	Solid state relay 1 A
8	Voltage supply output DC 12 V (e.g. for inductive proximity switch)
10	Interface RS422/485
11	Datalogger with interface RS485 <sup>b</sup>

**JUMO GmbH & Co. KG**

Delivery address: Mackenrodtstraße 14  
36039 Fulda, Germany  
Postal address: 36035 Fulda, Germany  
Phone: +49 661 6003-0  
Fax: +49 661 6003-607  
Email: mail@jumo.net  
Internet: www.jumo.net

**JUMO Instrument Co. Ltd.**

JUMO House  
Temple Bank, Riverway  
Harlow, Essex CM 20 2DY, UK  
Phone: +44 1279 63 55 33  
Fax: +44 1279 62 50 29  
Email: sales@jumo.co.uk  
Internet: www.jumo.co.uk

**JUMO Process Control, Inc.**

6733 Myers Road  
East Syracuse, NY 13057, USA  
Phone: +1 315 437 5866  
Fax: +1 315 437 5860  
Email: info.us@jumo.net  
Internet: www.jumousa.com



12	PROFIBUS-DP interface
<b>(7)</b>	<b>Power supply</b>
23	AC 110 to 230 V, +10/-15 %, 48 to 63 Hz
25	AC/DC 20 to 30 V, 48 to 63 Hz
<b>(8)</b>	<b>Extra code</b>
000	None

<sup>a</sup> All languages are available on the instrument and can be changed by the customer at any time. Factory default setting to a language (other than "German") is available for a charge.

<sup>b</sup> The only way to read data is with the PC setup software!

**Order code**                    (1)                    (2)                    (3)                    (4)                    (5)                    (6)                    (7)                    (8)                    /                    , ...<sup>a</sup>  
**Order example**                    202552/01                    -                    8                    -                    01                    -                    2                    -                    2                    -                    4                    -                    23                    /                    000

<sup>a</sup> List extra codes in sequence, separated by commas.

## Stock versions

(delivery 3 working days after receipt of order)

Order code	Part no.
202552/01-8-01-4-0-0-23/000	00550843

## Accessories

(delivery 10 working days after receipt of order)

Item	Part no.
Holder for C rail (PG 709710)	00375749
Dummy cover 96 mm × 48 mm (PG 709710)	00069680
Pipe mounting set (PG 209791)	00398162
Weather protection roof complete for basic type extension 05 (PG 209791)	00401174
PC setup software (PG 202599)	00560380
PC interface cable including USB/TTL converter and two adapters (USB connecting cable) (PG 709720)	00456352

Optional board	Code	Part no.
Analog input (universal)	1	00442785
Relay (1× changeover)	2	00442786
Relay (2× NO)	3	00442787
Analog output	4	00442788
2 PhotoMOS <sup>®</sup> relay	5	00566677
Solid state relay 1 A	6	00442790
Supply voltage output DC ±5 V (e.g. for ISFET)	7	00566681
Supply voltage output DC 12 V (e.g. for inductive proximity switch)	8	00566682
Interface RS422/485	10	00442782
Datalogger with RS485 interface	11	00566678
PROFIBUS-DP interface	12	00566679