



# PS-1250 12 Volt 5.0 AH

## Rechargeable Sealed Lead Acid Battery



**We've Got The Power.™**



### Features

- Absorbent Glass Mat (AGM) technology for superior performance
- Valve regulated, spill proof construction allows safe operation in any position
- Power/volume ratio yielding unrivaled energy density
- Rugged impact resistant ABS case and cover (UL94-HB)
- Approved for transport by air. D.O.T., I.A.T.A., F.A.A. and C.A.B. certified
- U.L. recognized under file number MH 20845

### Terminals (mm)

- F1 - Quick disconnect tabs, 0.187" x 0.032"  
Mate with AMP. INC. FASTON "187" series  
— OR —
- F2 - Quick disconnect tabs, 0.250" x 0.032"  
- Mate with AMP. INC FASTON "250" series

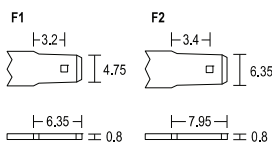

### Physical Dimensions: in (mm)

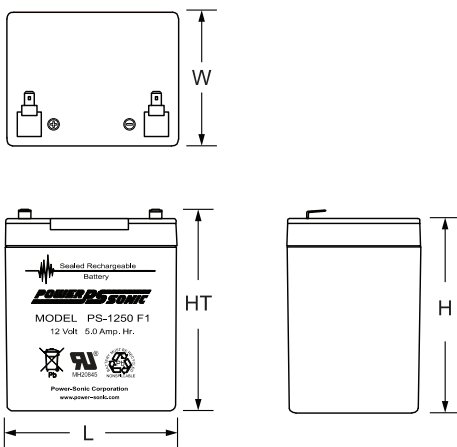

**L: 3.54 (90) W: 2.76 (70) H: 3.98 (101) HT: 4.21 (107)**

Tolerances are +/- 0.04 in. (+/- 1mm) and +/- 0.08 in. (+/- 2mm) for height dimensions. All data subject to change without notice.

### Performance Specifications

**Nominal Voltage** ..... 12 volts (6 cells)

#### Nominal Capacity

20-hr. (250mA to 10.50 volts) .....	5.00 AH
10-hr. (450mA to 10.50 volts) .....	4.50 AH
5-hr. (750mA to 10.20 volts) .....	3.75 AH
1-hr. (2.85A to 9.00 volts) .....	2.85 AH
15-min. (9A to 9.00 volts).....	2.25 AH

**Approximate Weight** ..... 3.50 lbs. (1.59 kg)

**Energy Density** (20-hr. rate) ..... 1.54 W-h/in<sup>3</sup> (94.16 W-h/l)

**Specific Energy** (20-hr. rate) ..... 17.14 W-h/lb (37.79 W-h/kg)

**Internal Resistance** (approx.) ..... 40 milliohms

**Max Discharge Current** (7 Min.) ..... 15.0 amperes

**Max Short-Duration Discharge Current** (10 Sec.)..... 50.0 amperes

#### Shelf Life (% of nominal capacity at 68 °F (20 °C))

1 Month .....	97%
3 Months.....	91%
6 Months .....	83%

#### Operating Temperature Range

Charge.. .....	-4 °F (-20 °C) to 122 °F (50 °C)
Discharge.....	-40 °F (-40 °C) to 140 °F (60 °C)

**Case** ..... ABS Plastic

**Power-Sonic Chargers** ..... PSC-12500A

**Shelf Life & Storage**

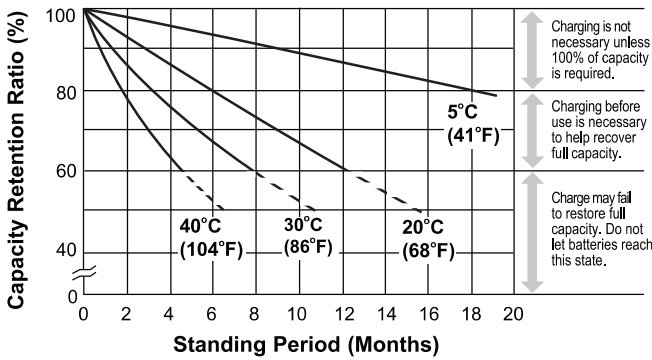

**Discharge Characteristics**

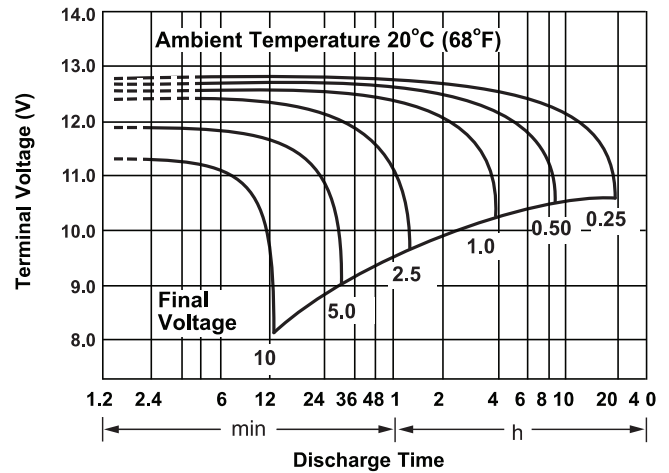

**Discharge Time vs. Discharge Current**

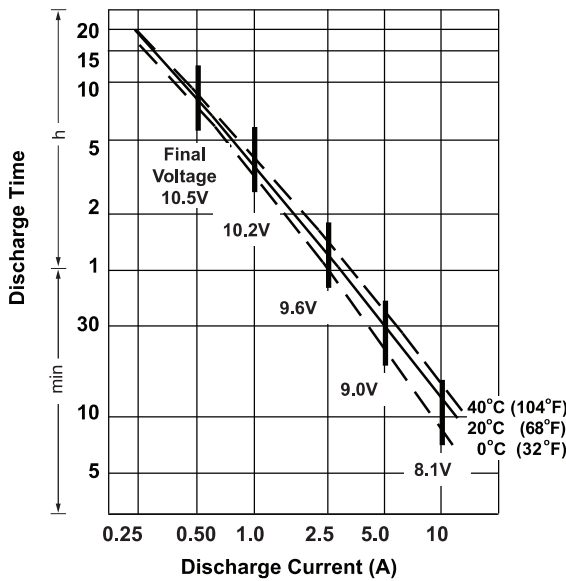

**Life Characteristics in Stand-By Use**

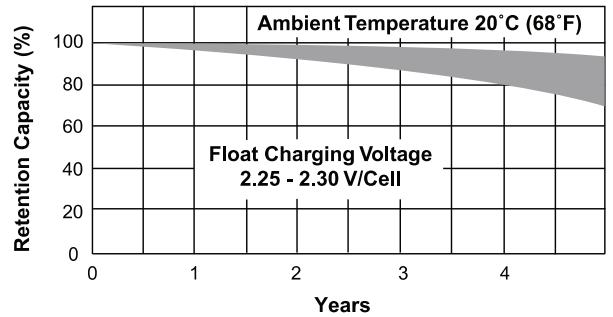

**Life Characteristics in Cyclic Use**

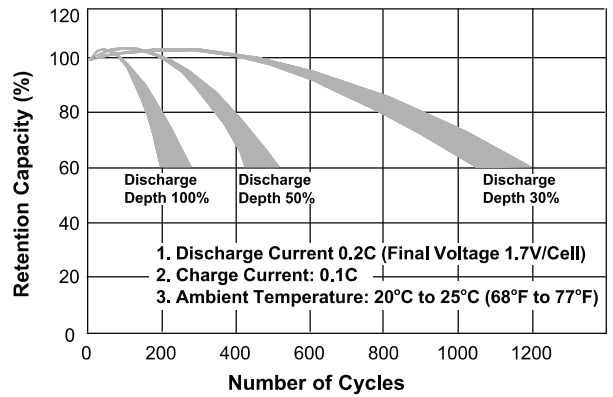

**Charging**

**Cycle Applications:** Limit initial current to 1.2A. Charge until battery voltage (under charge) reaches 14.4 to 14.7 volts at 68°F (20°C). Hold at 14.4 to 14.7 volts until current drops to under 50mA. Battery is fully charged under these conditions, and charger should be disconnected or switched to "float" voltage.

**"Float" or "Stand-By" Service:** Hold battery across constant voltage source of 13.5 to 13.8 volts continuously. When held at this voltage, the battery will seek its own current level and maintain itself in a fully charged condition.

**Note:** Due to the self-discharge characteristics of this type of battery, it is imperative that they be charged within 6 months of storage, otherwise permanent loss of capacity might occur as a result of sulfation.

**Chargers**

Power-Sonic offers a wide range of chargers suitable for batteries up to 100AH. Please refer to the Charger Selection Guide in our specification sheets for "C-Series Switch Mode Chargers" and "Transformer Type A and F Series". Please contact our Technical department for advice if you have difficulty in locating suitable models.

**Further Information**

Please refer to our website [www.power-sonic.com](http://www.power-sonic.com) for a complete range of useful downloads, such as product catalogs, material safety data sheets (MSDS), ISO certification, etc..

**Contact Information**

[www.power-sonic.com](http://www.power-sonic.com)

**DOMESTIC SALES**  
Tel: +1-619-661-2020  
Fax: +1-619-661-3650  
nationalsales@power-sonic.com

**CUSTOMER SERVICE**  
Tel: +1-619-661-2030  
Fax: +1-619-661-3648  
customer-service@power-sonic.com

**TECHNICAL SUPPORT**  
Tel: +1-619-661-2020  
Fax: +1-619-661-3648  
support@power-sonic.com

**INTERNATIONAL SALES**  
Tel: +1-650-364-5001  
Fax: +1-650-366-3662  
international-sales@power-sonic.com

**CORPORATE OFFICE** • 7550 Panasonic Way • San Diego, CA 92154 • USA • Tel: +1-619-661-2020 • Fax: +1-619-661-3650