

## VACUUM AND CHARGING HOSES





YELLOW JACKET®

## ***PLUS II™* Charging Hoses**

Double barrier protection for CFC, HCFC and HFC refrigerants



- 1/4" **PLUS II™** hoses are **UL recognized assemblies (File SA9737)**
- The nylon permeation barrier meets SAE requirements J2196 for CFC, HCFC and HFC refrigerants
- The moisture barrier provides improved resistance to moisture migration which contaminates expensive refrigerant
- 1/4" RYB **PLUS II™** hoses are rated for 4000 psi (276 bar) minimum burst and 800 psi (55 bar) maximum working pressure and an operating temperature of -20° to 180°F (-28.8° to 82.2°C)
- Minimum bend radius: 6" (152 mm)
- Made in the USA 

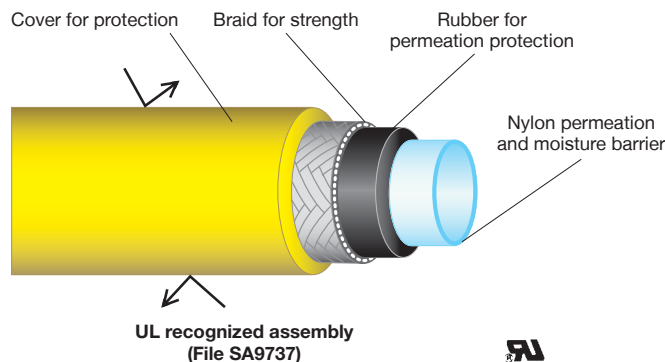

**PLUS II™ hoses with UL assemblies are available in the following configurations:**

- 1/4" with 1/4" flare fittings
- 1/4" with compact ball valve end
- 1/4" with SealRight™ low loss anti-blow back fitting
- 1/4" for 5/16" flare (1/2 – 20 thread) service ports for R-410A
- 1/4" with FlexFlow™ valve

PLUS II™ hose - standard 1/4" flare fittings				
Length	Yellow	Blue	Red	3 pak*
12"	21012	21212	21612	-
24"	21024	21224	21624	-
36"	21036	21236	21636	21983
48'	21048	21248	21648	21984
60"	21060	21260	21660	21985
72"	21072	21272	21672	21986
96"	21096	21296	21696	21988
10'	21110	21310	21710	-
12'	21112	21312	21712	-
25'	21125	21325	21725	-
50'	21150	21350	21750	-
75'	21175	21375	21775	-
100'	21200	21399	21799	-
Multi-length				21982 two 36", one 60" 21981 two 36", one 72"

\* 3 pak includes a red, yellow and blue hose.

Replacement parts	
UPC#	Description
19020	Replacement gasket (10 pak)
19302	"Adjust-a-Valve" opener (10 pak)



RECOVERY MACHINES  
VACUUM PUMP SYSTEMS  
VACUUM AND CHARGING HOSES  
HOSE ADAPTERS, VALVES AND PARTS  
CHARGING SYSTEMS  
GAUGES  
WIRELESS AND ELECTRONIC INSTRUMENTS  
HEATING INSTRUMENTS  
LEAK MONITORS AND DETECTORS  
SYSTEM TOOLS

## PLUS II™ 1/4" HOSE With compact ball valve end



- Metal handle at end of hose fits tight areas and traps all the gas
- Full flow valve
- Uses standard gasket and valve opener
- Recommended for R-410A
- Made in the USA 

UL recognized assemblies (File SA9737)

Compact ball valve end					
Length	Yellow	Blue	Red	3 pak	Black
36"	29036	29236	29636	29983	-
48"	29048	29248	29648	29984	-
60"	29060	29260	29660	29985	29595
72"	29072	29272	29672	29986	-
96"	29096	29296	29696	29988	-
10'	29110	29310	29710	-	-
12'	29112	29312	29712	-	-
25'	29125	29325	29725	-	-
50'	29150	29350	29750	-	-
75'	29175	29375	29775	-	-
100'	29199	29399	29799	-	-

Replacement parts	
UPC#	Description
19020	Replacement gasket (10 pak)
19302	"Adjust-a-Valve" opener (10 pak)

## PLUS II™ 1/4" HOSE With FlexFlow™ valve



- Valve handle position shows when valve is opened or closed
- Metal handle and smaller ergonomic valve with zero restriction for maximum flow
- Flexible length of hose between valve and fitting makes access to tight areas easier
- Recommended for R-410A
- Made in the USA 

UL recognized assemblies (File SA9737)

FlexFlow™ valve 8" from angle end				
Length	Yellow	Blue	Red	3 pak
36"	25036	25236	25636	25983
48"	25048	25248	25648	25984
60"	25060	25260	25660	25985
72"	25072	25272	25672	25986
96"	25096	25296	25696	25988
10'	25110	25310	25710	-
12'	25112	25312	25712	-
25'	25125	25325	25725	-
50'	25150	25350	25750	-
75'	25175	25375	25775	-
100'	25199	25399	25799	-

Replacement parts	
UPC#	Description
19020	Replacement gasket (10 pak)
19302	"Adjust-a-Valve" opener (10 pak)

## PLUS II™ 1/4" HOSE With SealRight™ low loss anti-blow back fitting



UL recognized assemblies (File SA9737)

- Low loss anti-blow back SealRight fitting immediately traps refrigerant in the hose when disconnected, helping meet non-venting regulations and prevent finger burns
- 45° end for easy installation in tight areas
- Gaskets resist deterioration from existing CFC, HCFC and HFC refrigerants and oils
- Available with SealRight fittings on both ends
- Made in the USA 

45° SealRight fitting at one end				
Length	Yellow	Blue	Red	3 pak
12"	22012	22212	22612	-
24"	22024	22224	22624	-
36"	22036	22236	22636	22983
48"	22048	22248	22648	22984
60"	22060	22260	22660	22985
72"	22072	22272	22672	22986
96"	22096	22296	22696	22988
10'	22110	22310	22710	-
12'	22112	22312	22712	-
25'	22125	22325	22725	-
50'	22150	22350	22750	-
75'	22175	22375	22775	-
100'	22200	22399	22799	-

UPC#	Multi-length 3 pak
22981	Two 36" RB, one 72" Y
22982	Two 36" RB, one 60" Y

Replacement parts	
UPC#	Description
19020	1/4" and 5/16" Replacement gasket (10 pak)
19037	SealRight "O" ring (10 pak)
19038	Plug and gasket
19039	Nut and clip
19040	SealRight repair kit with valve, gasket, plug, spring and two "O" rings
19041	Complete kit includes 19038, 19039 and 19040

## PLUS II™ 1/4" HOSE For 5/16" flare (1/2 – 20 thread) service ports for R-410A

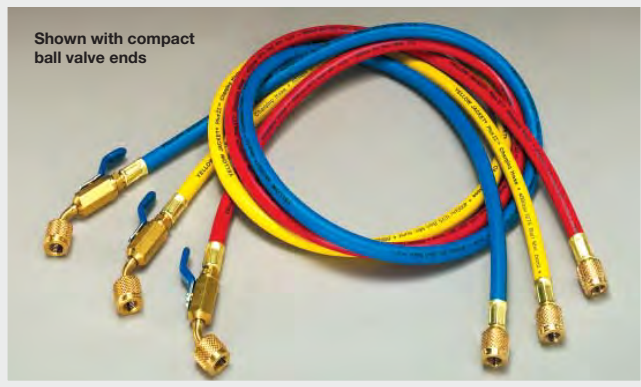

UL recognized assemblies (File SA9737)

- Available with standard fittings or compact ball valve
- Compatible with both POE and PVE oils
- Made in the USA

**PLUS II™ hose with 1/4" (7/16 – 20) Female flare on manifold connection and 5/16" (1/2 – 20) Female flare angled on service end**

Standard fitting			
Length	Yellow	Blue	Red
36"	21403	21423	21463
60"	21405	21425	21465
72"	21406	21426	21466

For use with R-410A tanks with 1/4" fittings  
\*Yellow PLUS II™ hose with standard 1/4" (7/16 – 20) flare fittings

Length		3 pak		
36"		21483 (21036*, 21423, 21463)		
60"		21485 (21060*, 21425, 21465)		
72"		21486 (21072*, 21426, 21466)		

**PLUS II™ hose with 5/16" (1/2 – 20) Female flare on manifold connection and 5/16" (1/2 – 20) Female flare angled on service end**

Standard fitting				
Length	Yellow	Blue	Red	3 pak
36"	21503	21523	21563	21583
60"	21505	21525	21565	21585
72"	21506	21526	21566	21586

**PLUS II™ hose with compact ball valve (1/4" x 5/16")**

Length	Yellow	Blue	Red
36"	29403	29423	29463
60"	29405	29425	29465
72"	29406	29426	29466

For use with R-410A tanks with 1/4" fittings  
\*Yellow PLUS II™ hose with 1/4" (7/16 – 20) compact ball valve fittings

Length		3 pak		
36"		29483 (29036*, 29423, 29463)		
60"		29485 (29060*, 29425, 29465)		
72"		29486 (29072*, 29426, 29466)		

**Compact ball valve (RYB 5/16" x 5/16")**

Length	Yellow	Blue	Red	3 pak
36"	29003	29203	29603	29993
60"	29005	29205	29605	29995
72"	29006	29206	29606	29996

**Replacement parts**

UPC#	Description
19020	1/4" and 5/16" Replacement gasket (10 pak)
19302	"Adjust-a-Valve" opener (10 pak)

## 9" FlexFlow™ AND LOW LOSS ADAPTER HOSES

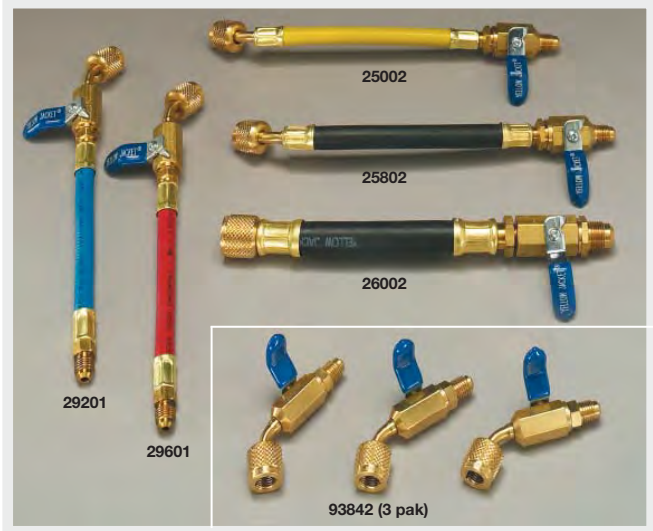

UL recognized assemblies (File SA9737) (Valves SA10088) (except 25802 and 26002)

- Easy retrofit of existing PLUS II™ hoses with ball valve capabilities
- Flexible hose between valve and fitting for handling in tight areas
- Operating temperature -20° to 180°F (-28.8° to 82.2°C)\*\*
- 800 psi working pressure\*\*\*
- Minimum bend radius: 8" (203 mm)
- Made in the USA

**Compact ball valve assemblies**

UPC#	Description
29001	1/4" Yellow ball valve adapter
29201	1/4" Blue ball valve adapter
29601	1/4" Red ball valve adapter
29980	29001, 29201, 29601 (3 pak)
93843	1/4" Compact ball valve – 45°
93842	1/4" Compact ball valve – 45° (3 pak)

**FlexFlow™ assemblies**

UPC#	Description
25002	1/4" Yellow FlexFlow adapter
25202	1/4" Blue FlexFlow adapter
25602	1/4" Red FlexFlow adapter
25980	25002, 25202, 25602 (3 pak)
25802	1/4" Heavy duty FlexFlow adapter*
26002	3/8" Heavy duty FlexFlow adapter**/***
26202	Yellow standard "B" FlexFlow adapter**/***
27002	Acme 1/2" Yellow FlexFlow adapter
19095	Set of 2 handles and screws

\*25802 and 26002: Operating temperature -22° to 176°F (-30° to 80°C)  
\*\*26202: Operating temperature -20° to 200°F (-28.8° to 93.3°C)  
\*\*\*26002 and 26202: 3000 psi (207 bar) burst and 600 psi (41 bar) working pressures

**Replacement parts**

UPC#	Description
19011	3/8" Replacement gasket (10 pak)
19020	1/4" Replacement gasket (10 pak)
19302	"Adjust-a-Valve" opener (10 pak)

Underwriters Laboratories Inc. Registered Component Mark – applies to all standard 1/4" PLUS II™ and 1/4" RYB FlexFlow™ hoses on pages 21-23.



## PLUS II™ 3/8" "B" CHARGING HOSE

PLUS II™ features in a larger volume hose for fast, high vacuum or charging.

- 3000 psi (207 bar) minimum burst, 600 psi (41 bar) maximum working pressure
- Operating temperature -20° to 180°F (-28.8° to 82.2°C)
- Minimum bend radius: 6" (152 mm)
- Large selection of fittings available
- Made in the USA

### Replacement parts

UPC#	Description
19011	3/8" Replacement gasket (10 pak)

Length	Common selections					Other selections				
	3/8" Str. fl. x 3/8" Str. fl.			3/8" fl. x FlexFlow	3/8" Str. fl. x 3/8" 45°			3/8" Str. fl. x 3/8" 90°	1/4" Str. fl. x 1/4" 45°	
	Yellow	Blue	Red		Yellow	Blue	Red			
36"	14536	B36	27836	28036	26236	18136	28236	28436	20036	20436
48"	14548	B48	27848	28048	26248	18148	28248	28448	20048	20448
60"	14560	B60	27860	28060	26260	18160	28260	28460	20060	20460
72"	14572	B72	27872	28072	26272	18172	28272	28472	20072	20472
96"	14596	B96	27896	28096	26296	18196	28296	28496	20096	20496
10'	14610	B120	27910	28110	26310	18210	28310	28510	20110	20510
12'	14612	B144	27912	28112	26312	18212	28312	28512	20112	20512
25'	14625	B300	27925	28125	26325	18225	28325	28525	20125	20525
50'	14650	B600	27950	28150	26350	18250	28350	28550	20150	20550
75'	14675	B900	27975	28175	26375	18275	28375	28575	20175	20575
100'	14699	B1200	27999	28199	26399	18299	28399	28599	20199	20599



## PLUS II™ 1/4" HEAVY DUTY CHARGING HOSE

Heavy duty construction for substantially increased service life.

- Flexibility for all-weather easy handling
- Pulls 75 micron vacuum or better on 36" hose
- 4000 psi (276 bar) minimum burst, 800 psi (55 bar) maximum working pressure
- Operating temperature -22° to 176°F (-30° to 80°C)
- Minimum bend radius: 6" (152 mm)
- Made in the USA

### Replacement parts

UPC#	Description
19020	Replacement gasket (10 pak)
19302	"Adjust-a-Valve" opener (10 pak)

Length	Common selections			Other selections				
	HCA hose Str. x angle		Hose with FlexFlow™	Hose with ball valve	HCL hose Str. x 90°		HCS hose Str. x Str.	
12"	15012	HCA-12"	-	-	15212	HCL-12"	15412	HCS-12"
24"	15024	HCA-24"	-	-	15224	HCL-24"	15424	HCS-24"
36"	15036	HCA-36"	25836	29836	15236	HCL-36"	15436	HCS-36"
48"	15048	HCA-48"	25848	29848	15248	HCL-48"	15448	HCS-48"
60"	15060	HCA-60"	25860	29860	15260	HCL-60"	15460	HCS-60"
72"	15072	HCA-72"	25872	29872	15272	HCL-72"	15472	HCS-72"
96"	15096	HCA-96"	25896	29896	15296	HCL-96"	15496	HCS-96"
10'	15110	HCA-120"	25910	29910	Black only. Longer lengths available. Please specify.			
12'	15112	HCA-144"	25912	29912				
25'	15125	HCA-300"	25925	29925				
50'	15150	HCA-600"	25950	29950				
75'	15175	HCA-900"	25975	29975				
100'	15199	HCA-1200"	25999	29999				

## PLUS II™ 3/8" HEAVY DUTY COMBINATION CHARGING/VACUUM HOSE

Pulls a vacuum much faster than the 1/4" hose.

- Operating temperature -22° to 176°F (- 30° to 80°C)
- 3000 psi (207 bar) minimum burst, 600 psi (41 bar) maximum working pressure
- Minimum bend radius: 8" (203 mm)
- Made in the USA 



Replacement parts	
UPC#	Description
19020	1/4" Replacement gasket (10 pak)
19011	3/8" Replacement gasket (10 pak)
19302	"Adjust-a-Valve" opener (10 pak)

Common selections				Other selections				
Length	3/8" Str. fl. x 3/8" Str. fl.	3/8" Str. fl. x FlexFlow™	3/8" fl. x 3/8" 45°	3/8" fl. x 3/8" 90°	3/8" fl. x 1/4" 45°	1/4" fl. x 1/4" 45°		
36"	15636 BC-36"	26036	19636	19836	16236 BCA-36"	20236		
48"	15648 BC-48"	26048	19648	19848	16248 BCA-48"	20248		
60"	15660 BC-60"	26060	19660	19860	16260 BCA-60"	20260		
72"	15672 BC-72"	26072	19672	19872	16272 BCA-72"	20272		
96"	15696 BC-96"	26096	19696	19896	16296 BCA-96"	20296		
10'	15710 BC-120"	26110	19710	19910	Longer lengths available. Please specify. Longer than 8' not recommended for evacuation.	20310		
12'	15712 BC-144"	26112	19712	19912		20312		
25'	15725 BC-300"	26125	19725	19925		20325		
50'	15750 BC-600"	26150	19750	19950		20350		
75'	15775 BC-900"	26175	19775	19975		20375		
100'	15799 BC-1200"	26199	19799	19999		20399		

## PLUS II™ 1/2" AND 5/8" HEAVY DUTY COMBINATION CHARGING/VACUUM HOSE

Heavy duty construction with PLUS II™ barrier technology reduces permeation and vacuum loss. Large I.D. reduces vacuum time substantially over 1/4" or 3/8" hose.

- Pull a more complete vacuum
- Faster refrigerant transfer
- Faster charging on large systems
- 3000 psi (207 bar) minimum burst, 600 psi (41 bar) maximum working pressure
- Operating temperature -22° to 176°F (-30° to 80°C)
- Other fittings available on request
- Minimum bend radius: 10" (254 mm)
- Made in the USA 



Replacement parts	
UPC#	Description
19015	1/2" and 5/8" Replacement gaskets
19020	1/4" Replacement gasket (10 pak)
19011	3/8" Replacement gasket (10 pak)
19302	"Adjust-a-Valve" opener (10 pak)

Common selections				Other selections					
Length	"C" 1/2" fl. x 1/2" fl.	"D" 5/8" fl. x 5/8" fl.	"CA" 1/4" angle end x 1/2" fl.	"DA" 1/4" angle end x 5/8" fl.	1/2" fl. x 3/8" fl.	3/8" fl. x 3/8" fl.			
36"	15836 C-36"	16036 D-36"	16436 CA-36	16636 DA-36	19236	20636			
48"	15848 C-48"	16048 D-48"	16448 CA-48	16648 DA-48	19248	20648			
60"	15860 C-60"	16060 D-60"	16460 CA-60	16660 DA-60	19260	20660			
72"	15872 C-72"	16072 D-72"	16472 CA-72	16672 DA-72	19272	20672			
96"	15896 C-96"	16096 D-96"	16496 CA-96	16696 DA-96	19296	20696			
10'	15910 C-120"	16110 D-120"	36" hose will pull to 25 microns and lower. Hoses longer than 8' not recommended for evacuation.			19310	20710		
12'	15912 C-144"	16112 D-144"				19312	20712		
25'	15925 C-300"	16125 D-300"				19325	20725		
50'	15950 C-600"	16150 D-600"				19350	20750		

Black only. Longer lengths available. Specify type, length and fitting combination.

RECOVERY MACHINES  
VACUUM PUMP SYSTEMS  
VACUUM AND CHARGING HOSES  
HOSE ADAPTERS, VALVES AND PARTS  
CHARGING SYSTEMS  
GAUGES  
WIRELESS AND ELECTRONIC INSTRUMENTS  
HEATING INSTRUMENTS  
LEAK MONITORS AND DETECTORS  
SYSTEM TOOLS



## PLUS II™ 3/4" HEAVY DUTY CHARGING HOSE



Large 3/4" I.D. designed to save time in charging or evacuation of centrifugals and other large systems.

- Constructed for heavy duty use with most refrigerants
- 3000 psi (206 bar) minimum burst, 600 psi (41 bar) maximum working pressure
- Available with steel 3/4" Female, 3/4" Male flares, 3/4" Male pipe or hex fittings
- Operating temperature -20° to 200°F (-28.8° to 93.3°C)
- Minimum bend radius: 12" (305 mm)
- Not for use with NH<sub>3</sub>

Length	3/4" fl. x 3/4" fl. – "O" ring seal	3/4" hex x 3/4" hex copper gasket seal
12"	18412 E-12"	20812
24"	18424 E-24"	20824
36"	18436 E-36"	20836
48"	18448 E-48"	20848
60"	18460 E-60"	20860
72"	18472 E-72"	20872
96"	18496 E-96"	20896
10'	18510 E-120"	20910
12'	18512 E-144"	20912
25'	18525 E-300"	20925
50'	18550 E-600"	20950

### Replacement parts

UPC#	Description
19012	3/4" "O" ring
59655	3/4" Copper gasket

## AUTOMOTIVE MANIFOLD HOSES FOR R-134A SYSTEMS

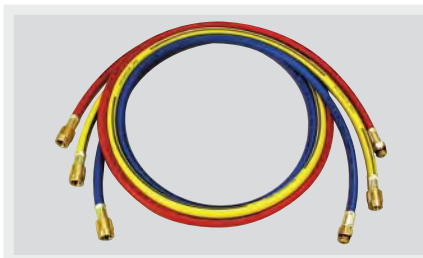

These 1/4" hoses combine PLUS II™ hose with 1/2" Acme fittings to meet SAE requirements. You get PLUS II™ double barrier protection in a hose manufactured specifically for automotive applications. Fitting threads are 1/2" Acme Female and 14 mm Male fittings.

Color	Yellow	Blue	Red	3 pak
Length	SealRight Straight x 45° Acme	1/2" fe. Acme x 14 mm Male	1/2" fe. Acme x 14 mm Male	
60"	27460	27660	27260	27102
72"	27472	27672	27272	27101
96"	27496	27696	27296	27104
10'	27510	27710	27310	27103

## AUTOMOTIVE CHARGING MANIFOLD AND HOSES FOR 1234YF SYSTEMS



Charging manifold and hoses designed specifically for 1234yf. Manifold body made of lightweight forged aluminum alloy for handling ease and the durability and reliability required for repeated use. Hoses SAE J2788 approved.

Color	Yellow	Blue	Red
Length	3/16" hose (12 mm barb x 45° QC)	3/16" hose (12 mm x 12 mm barb)	
36"	17803	17823	17863
48"	17804	17824	17864
60"	17805	17825	17865
72"	17806	17826	17866
96"	17808	17828	17868
120"	17810	17830	17870
144"	17812	17832	17872
180"	17815	17835	17875

### 1234yf Test & Charging Manifold

49849	TITAN 2-Valve Manifold with 72 PLUS II™ SAE RYB hoses with couplers, R/B gauges, bar/psi/kPa, R1234yf, °F
-------	---

## SPECIAL 1/4" PLUS II™ CHARGING HOSES

YELLOW JACKET 1/4" yellow charging hoses with special fittings include straight, 3/8" and 90° fittings. Red and blue hoses also available.

Length	1/4" fl. x 1/4" 90° fl.	1/4" fl. x 1/4" fl.	1/4" fl. x 3/8" fl.
36"	12036 HL36	13036 HS36	14036 HB36
48"	12048 HL48	13048 HS48	14048 HB48
60"	12060 HL60	13060 HS60	14060 HB60
72"	12072 HL72	13072 HS72	14072 HB72

Longer lengths available. Please specify.

### Replacement parts

UPC#	Description/Quantity
19010	1/4" Gasket (6 pak) and valve depressor (3 pak)
19020	Replacement gasket (10 pak)
19302	"Adjust-a-Valve" opener (10 pak)

90° for tight areas

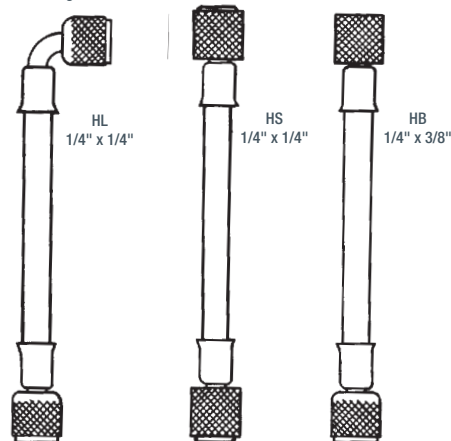

RECOVERY MACHINES  
VACUUM PUMP SYSTEMS  
VACUUM AND CHARGING HOSES  
HOSE ADAPTERS, VALVES AND PARTS  
CHARGING SYSTEMS  
GAUGES  
WIRELESS AND ELECTRONIC INSTRUMENTS  
HEATING INSTRUMENTS  
LEAK MONITORS AND DETECTORS  
SYSTEM TOOLS



# HOSE COMPARISON CHART

1/4" Flexible hoses	3/8" Flexible hoses	1/2" and 5/8" Flexible hoses
Easily connects to 1/4" Male flare access fitting on system	Evacuates and charges faster than 1/4" hose	Evacuates and charges faster than 1/4" hose Allows you to pull a deeper vacuum More efficient job of removing moisture and contaminants from the system
<b>PLUS II™ 1/4" Charging hose (SealRight™, FlexFlow and ball valve ends)</b> Adjust-a-Valve™ valve core depressor easily opens all out-of-tolerance Schrader valves (SealRight hoses offer different technology) <i>PLUS II™</i> hoses offer double barrier protection Nylon layer for permeation, braid for strength, and outer cover for protection Fully UL recognized assemblies (File SA9737)	<b>PLUS II™ 3/8" Charging hose</b> <i>PLUS II™</i> hoses with double barrier protection	<b>PLUS II™ 1/2" and 5/8" Charging hose</b> <i>PLUS II™</i> hoses with double barrier protection Large I.D. reduces vacuum time substantially over 1/4" or 3/8" hose Faster refrigerant transfer and faster charging on large systems Wide selection of fittings are available
<b>Temp:</b> -20° to 180°F (-28.8° to 82.2°C)	<b>Temp:</b> -20° to 180°F (-28.8° to 82.2°C)	<b>Temp:</b> -22° to 176°F (-30° to 80°C)
<b>Burst:</b> 4000 psi (276 bar) minimum	<b>Burst:</b> 3000 psi (207 bar) minimum	<b>Burst:</b> 3000 psi (207 bar) minimum
<b>Working:</b> 800 psi (55 bar) maximum	<b>Working:</b> 600 psi (41 bar) maximum	<b>Working:</b> 600 psi (41 bar) maximum
<b>Safety factor:</b> 5 to 1	<b>Safety factor:</b> 5 to 1	<b>Safety factor:</b> 5 to 1
<b>Available lengths:</b> 12 inches to 100 feet	<b>Available lengths:</b> 12 inches to 100 feet	<b>Available lengths:</b> 12 inches to 100 feet



The "Adjust-a-Valve" valve core depressor easily opens out-of-tolerance Schrader valves. Simply adjust height with needle nose pliers. Designed for repeat usage; replacement is convenient.

### Inspect your hoses on a regular basis.

Since 1964, YELLOW JACKET 1/4" charging hoses have "year of manufacture" coded or listed on the rim of the nut. Prior to 2006, a series of I's, X's, O's, A's, B's or C's indicated the year. Since mid-2006, the actual year of manufacture has been used. **If your hoses are more than five years old, we recommend that you replace them.**

Fittings available PLUS II™ hoses			
Type	Str.	45°	90°
1/8" Female flare			
3/16" Female flare			
1/4" Female flare			
1/4" Female SealRight™			
3/8" Female flare			
5/16" Female flare			
1/4" Male flare			
1/8" NPT Male			
1/4" NPT Male			
1/2" Female Acme			
14 mm Male			

Not all hose and fitting combinations are listed in this catalog. Ask for specifics.

6	1964	4 BBBB	1997
1	1970	3 BBB	1998
6 IIIII	1971	2 BB	1999
1 I	1976	1 B	2000
6 XXXXXX	1977	6 CCCCCC	2001
1 X	1982	5 CCCCC	2002
6 OOOOOO	1983	4 CCCC	2003
1 O	1988	3 CCC	2004
6 AAAAAA	1989	2 CC	2005
1 A	1994	1 C or 2006	2006
6 BBBBBB	1995	2007	2007
5 BBBBB	1996		

All after 2007 are stamped with year of mfg.

Ounces of liquid held per foot of hose at 80° F							
Hose type	R-12	R-22	R-134a	R-404A	R-407C	R-410A	R-502
1/4" PLUS II™	0.36	0.33	0.33	0.29	0.31	0.29	0.33
1/4" Heavy duty	0.34	0.31	0.32	0.27	0.30	0.28	0.32
3/8" PLUS II™	0.85	0.77	0.78	0.67	0.73	0.68	0.78
3/8" Heavy duty	0.85	0.77	0.78	0.67	0.73	0.68	0.78
1/2" Heavy duty	1.85	1.68	1.70	1.47	1.60	1.49	1.71
3/4" Heavy duty	3.89	3.53	3.58	3.09	3.37	3.13	3.60

RECOVERY MACHINES  
VACUUM PUMP SYSTEMS  
VACUUM AND CHARGING HOSES  
HOSE ADAPTERS, VALVES AND PARTS  
CHARGING SYSTEMS  
GAUGES  
WIRELESS AND ELECTRONIC INSTRUMENTS  
HEATING INSTRUMENTS  
LEAK MONITORS AND DETECTORS  
SYSTEM TOOLS

RECOVERY MACHINES  
VACUUM PUMP SYSTEMS  
VACUUM AND CHARGING HOSES  
HOSE ADAPTERS, VALVES AND PARTS  
CHARGING SYSTEMS  
GAUGES  
WIRELESS AND ELECTRONIC INSTRUMENTS  
HEATING INSTRUMENTS  
LEAK MONITORS AND DETECTORS  
SYSTEM TOOLS

## AMMONIA CHARGING HOSE



Available black only

Designed with steel quick couplers at both ends. Features include:

- Regular CH20 gaskets for 1/4" hoses (19010, 19020). CH11 gaskets for 3/8" hoses (19011)
- 1/4" and 3/8" – 2500 psi (172 bar) minimum burst, 500 psi (34 bar) maximum working pressure
- 1/4" operating temperature -20° to 176°F (-28.8° to 80°C) and minimum bend radius: 6" (152 mm)
- 3/8" operating temperature -22° to 176°F (-30° to 80°C) and minimum bend radius: 8" (203 mm)
- Made in the USA

1/4" Str. fl. x 1/4" 45°			3/8" Str. fl. both ends	
UPC#	Part#	Length	UPC#	Part#
16848	NHA-48"	48"	19448	NBC-48"
16872	NHA-72"	72"	19472	NBC-72"
16896	NHA-96"	96"	19496	NBC-96"
16910	NHA-120"	10'	19510	NBC-120"
16912	NHA-144"	12'	19512	NBC-144"

### Steel half union ammonia fittings

UPC#	Description
16801	1/4" Male fl. x 1/4" NPT Male Str.
16802	1/4" Male fl. x 1/4" NPT Male 90°
16803	3/8" Male fl. x 1/4" NPT Male

NH<sub>3</sub> manifold on page 46.

## CYLINDER VALVE HOSES

### With finger tight drum fitting

Designed for finger tight operation on 125 lb. and 145 lb. refrigerant cylinders. Gaskets seal without wrenches.



UPC#	L.	Part#	Type	Fittings	Burst pressure	Working pressure	Operating temp.	Min. bend radius
18612	12"	CVX-12	1/4" Heavy duty	1/4" Male flare x 3/4" NPS	4000 psi (276 bar)	800 psi (55 bar)	-22 to 176 (-30° to 80°C)	6" (152 mm)
18912	12"	CVY-12	3/8" Heavy duty	3/8" Male flare x 3/4" NPS	3000 psi (207 bar)	600 psi (41 bar)	-22 to 176 (-30° to 80°C)	8" (203 mm)
18072	72"	CVH-72	1/4" Original	1/4" Female flare x 3/4" NPS	2500 psi (172 bar)	500 psi (34 bar)	-20 to 180 (-28.8° to 82.2°C)	6" (152 mm)
18372	72"	CVB-72	3/8" Standard	3/8" Female flare x 3/4" NPS	3000 psi (207 bar)	600 psi (41 bar)	-20 to 200 (-28.8° to 93.3°C)	6" (152 mm)

## FUEL OIL ASSEMBLY HOSES

Reinforced hose designed for quick pump to nozzle connection and oil burner connections.

- Flexible to absorb vibration and swelling while providing positive cut-off
- 4000 psi (276 bar) minimum burst and 800 psi (55 bar) maximum working pressure
- Operating temperature -20° to 180°F (-28.8° to 82.2°C)
- Minimum bend radius: 6" (152 mm)
- Made in the USA



UPC#	Length	Description
78041	12"	3/16" Female flare x 3/16" Female flare Pump to nozzle connector
78042	12"	1/4" Female flare x 1/4" Female flare Pump to nozzle connector
78112	12"	1/8" NPT Female swivel x 1/8" NPT Male Pump to nozzle connector or gauge to pump
78043	18"	3/16" Female flare x 3/16" Female flare Pump to nozzle connector
78044	18"	1/4" Female flare x 1/4" Female flare Pump to nozzle connector

Longer lengths available.

## OIL PUMP VIBRATION ELIMINATOR

Reinforced rubber hose helps eliminate noise and vibration when installed in a heating system.

- 3000 psi (207 bar) minimum burst, 600 psi (41 bar) maximum working pressure
- Operating temperature -20° to 180°F (-28.8° to 82.2°C)
- Minimum bend radius: 6" (152 mm)



UPC#	Length	Description
78012	12"	3/8" Male flare x 1/4" NPT Male oil burner connector

# HIGH PRESSURE CONTROL HOSE

## For HFC, HCFC and CFC refrigerants



The YELLOW JACKET® pressure control hose is constructed of a thermoplastic polymer inner tube and cover. This new material eliminates the vibration problems that are present in copper capillary tube installations.

The higher temperature ratings of this thermoplastic to 266° F eliminate the failures caused by maximum load conditions on rubber type pressure control hoses.

Between the inner tube and the cover, the hose is reinforced with a polyester braid of high tensile strength with high modulus, giving it the ability to withstand higher pressures.

Available in any combination of 1/4" or 3/8" brass SAE flare straight or 90° angle fittings. Hex nuts are steel and finished with black zinc. Copper gaskets provide the best possible seal.

- Improved permeation characteristics. R-134a permeation tested at: 0.188 oz./ft./yr. 0.0118 lb./ft./yr 17.6 gr./m./yr.
- Results with other refrigerants will also show superior performance characteristics
- For use with most HFCs such as R-134a, R-404A, R-407A, R-407B, R-407C, R-410A and R-507, and HCFC such as R-22
- Usable oil types include polyol ester, alkylbenzene and mineral oils.

### Specifications

I.D.: .156" (4.0 mm)  
 O.D.: .325" (8.2 mm)  
 Working pressure: 800 psi, 55 bar, 5.5 MPa  
 Burst pressure: 4000 psi, 276 bar, 27.6 MPa  
 Minimum temperature: -49° F (-44° C)  
 Maximum temperature: 266° F (130° C)  
 Minimum bend radius: 4" (102 mm)

Length* (assembly)	UPC#				
	1/4" Str. x Str.	1/4" Str. x 90°	1/4" 90° x 90°	3/8" Str. x Str.	3/8" Str. x 90°
12"	78612	78712	78812	78912	79112
18"	78618	78718	78818	78918	79118
24"	78624	78724	78824	78924	79124
30"	78630	78730	78830	78930	79130
36"	78636	78736	78836	78936	79136
48"	78648	78748	78848	78948	79148
60"	78660	78760	78860	78960	79160
72"	78672	78772	78872	78972	79172
96"	78696	78796			

\* Special lengths are readily available.



RECOVERY MACHINES  
 VACUUM PUMP SYSTEMS  
 VACUUM AND CHARGING HOSES  
 HOSE ADAPTERS, VALVES AND PARTS  
 CHARGING SYSTEMS  
 GAUGES  
 WIRELESS AND ELECTRONIC INSTRUMENTS  
 HEATING INSTRUMENTS  
 LEAK MONITORS AND DETECTORS  
 SYSTEM TOOLS



# STAINLESS STEEL HOSE SPECIFICATIONS

YELLOW JACKET stainless steel assemblies are 300 series corrugated hose and braid for applications where temperature and pressure could be a problem.

With stainless steel braid wrapping a stainless steel core, all hoses on this page prevent permeation and moisture infusion. Use with all standard refrigeration oils and refrigerants, as well as the new alternative oils and refrigerants including R-123.

Applications: vacuum and charging, vibration isolation, movable components and permanent application. **Not for use with NH<sub>3</sub>.**

Standard and custom length assemblies are made to order. Minimum length 12."

Stainless steel hose specifications				
Size	Max psi working*	Flexing bend radius	Permanent bend radius	Temperature/pressure correction
1/4"	1275 (88 bar)	5.5"	1"	68°F - 1.00
3/8"	1000 (69 bar)	6.5"	1-1/4"	200°F - .86
1/2," 5/8"	1000 (69 bar)	8.5"	1-1/2"	300°F - .80
3/4," 7/8"	725 (50 bar)	10"	2"	400°F - .78
1," 1-1/8"	700 (48 bar)	11.5"	2-3/4"	500°F - .77
1-1/4," 1-3/8"	550 (38 bar)	13"	3-1/4"	800°F - .76
				900°F - .74
				1000°F - .70

\* PSI at 68°F with a 4-to-1 safety factor. Core is T-321 SS with 300 Series SS braid.

## QUICK COUPLER ASSEMBLY

### For vacuum and charging

Oversized to increase flow and speed evacuation. Pull 25 microns and better on 36" length.

- Brass quick coupler
- Standard 45° angle at one end on 1/4" and 3/8" (90° available)
- Straight fittings only on 1/2", 5/8" and 3/4"
- Made in the USA 



Length	Str. x 45° 1/4" I.D.	Str. x 45° 3/8" I.D.	Str. x Str. 1/2" I.D.	Str. x Str. 5/8" I.D.	Str. x Str. 3/4" I.D.
36"	81636	81736	81836	81936	82036
48"	81648	81748	81848	81948	82048
60"	81660	81760	81860	81960	82060

## SWEAT FITTING ASSEMBLY



Female sweat fitting		Male sweat fitting	
86136	1/4" x 36"	85136	1/4" x 36"
86236	3/8" x 36"	85236	3/8" x 36"
86336	1/2" x 36"	85336	1/2" x 36"
86436	5/8" x 36"	85436	5/8" x 36"
86536	3/4" x 36"	85536	3/4" x 36"
86636	7/8" x 36"	85636	7/8" x 36"
86736	1-1/8" x 36"	85736	1-1/8" x 36"
86836	1-3/8" x 36"	85836	1-3/8" x 36"

Manufactured with straight, copper sweat ends.

- Male sweat to fit inside mating tube
- Female sweat to fit outside mating tube
- Made in the USA 

## FLARE ASSEMBLY

### For display cases, etc.



Stainless steel assemblies are made with a combination of Male and Female flares. Custom assemblies can be made. 

Fl. size x length	Male fl. x Male fl.	Male fl. x Fe. fl.	Fe. fl. x Fe. fl.
1/4" x 36"	82136	83136	84136
1/4" x 48"	82148	83148	84148
3/8" x 36"	82236	83236	84236
3/8" x 48"	82248	83248	84248
1/2" x 36"	82336	83336	84336
1/2" x 48"	82348	83348	84348
5/8" x 36"	82436	83436	84436
5/8" x 48"	82448	83448	84448
3/4" x 36"	82536	83536	84536
3/4" x 48"	82548	83548	84548

NOTE: Stainless steel hoses are made-to-order and cannot be returned.

NOTE: Custom lengths are available for all stainless steel hose assemblies on this page.

## GET MAXIMUM BENEFIT FROM YOUR YELLOW JACKET METAL HOSES

Keep your hoses on the job longer and the YELLOW JACKET warranty in effect by avoiding sharp bending and twisting that causes early failure. The warranty does not cover fatigue failure. Replace gaskets in quick couplers as needed to ensure a proper sealing.

RECOVERY MACHINES  
VACUUM PUMP SYSTEMS  
VACUUM AND CHARGING HOSES  
HOSE ADAPTERS, VALVES AND PARTS  
CHARGING SYSTEMS  
GAUGES  
WIRELESS AND ELECTRONIC INSTRUMENTS  
HEATING INSTRUMENTS  
LEAK MONITORS AND DETECTORS  
SYSTEM TOOLS